

SONY.

VAIO® MicroTower Reference Manual

PCV-E204



Notice to Users

© 1998 Sony Electronics Inc. All rights reserved. This manual and the software described herein, in whole or in part, may not be reproduced, translated, or reduced to any machine-readable form without prior written approval.

SONY ELECTRONICS INC. PROVIDES NO WARRANTY WITH REGARD TO THIS MANUAL, THE SOFTWARE, OR OTHER INFORMATION CONTAINED HEREIN AND HEREBY EXPRESSLY DISCLAIMS ANY IMPLIED WARRANTIES OF MERCHANTABILITY OR FITNESS FOR ANY PARTICULAR PURPOSE WITH REGARD TO THIS MANUAL, THE SOFTWARE, OR SUCH OTHER INFORMATION. IN NO EVENT SHALL SONY ELECTRONICS INC. BE LIABLE FOR ANY INCIDENTAL, CONSEQUENTIAL, OR SPECIAL DAMAGES, WHETHER BASED ON TORT, CONTRACT, OR OTHERWISE, ARISING OUT OF OR IN CONNECTION WITH THIS MANUAL, THE SOFTWARE, OR OTHER INFORMATION CONTAINED HEREIN OR THE USE THEREOF.

Sony Electronics Inc. reserves the right to make any modification to this manual or the information contained herein at any time without notice. The software described herein may also be governed by the terms of a separate user license agreement.

Sony VAIO, and the VAIO logo are trademarks of Sony. Microsoft, Windows, and the Windows 98 logo are registered trademarks of Microsoft Corporation. Intel, and Pentium are trademarks of Intel Corporation. K56flex is a trademark of Lucent Technologies Inc. and Rockwell International. All other trademarks are trademarks of their respective owners.

Safety Information

Owner's Record

The model number and serial number are located on the back of your VAIO computer. Record the serial number in the space provided here. Refer to the model and serial number when you call your Sony Service Center.

Model Number: PCV-E204

Serial Number: _____

WARNING

- To prevent fire or shock hazard, do not expose your VAIO computer to rain or moisture.
- Never install modem or telephone wiring during a lightning storm.
- Never install telephone jacks in wet locations unless the jack is specifically designed for wet locations
- Never touch uninsulated telephone wire or terminals unless the telephone line has been disconnected at the network interface.
- Use caution when installing or modifying telephone lines.
- Avoid using the modem during an electrical storm.
- Do not use the modem or a telephone to report a gas leak in the vicinity of the leak.

! The use of optical instruments with this product will increase eye hazard.

Regulatory Information

Declaration of Conformity

Trade Name: SONY
Model No.: PCV-E204
Responsible Party:
Sony Electronics Inc.
Address:
1 Sony Drive
Park Ridge, NJ 07656
Telephone No: 201-930-6970

This device complies with Part 15 of FCC Rules. Operation is subject to the two following conditions: (1) This device may not cause harmful interference, and (2) this device must accept any interference received, including interference that may cause undesired operation.

This equipment has been tested and found to comply with the limits for a Class B digital device, pursuant to Part 15 of the Rules. These limits are designed to provide reasonable protection against harmful interference in a residential installation. This equipment generates, uses, and can radiate radio frequency energy and, if not installed and used in accordance with the instructions, may cause harmful interference to radio communications. However, there is no guarantee that interference will not occur in a particular installation. If this equipment does cause harmful interference to radio or television reception, which can be determined by turning the equipment off and on, the user is encouraged to try to correct the interference by one or more of the following measures:

- Reorient or relocate the receiving antenna.
- Increase the separation between the equipment and the receiver.
- Connect the equipment into an outlet on a circuit different from that to which the receiver is connected.

- Consult the dealer or an experienced radio/TV technician for help.

You are cautioned that any changes or modifications not expressly approved in this manual could void your authority to operate this equipment.

Only peripherals (computer input/output devices, terminals, printers, etc.) that comply with FCC Class B limits may be attached to this computer product.

Operation with non-compliant peripherals is likely to result in interference to radio and television reception.

All cables used to connect peripherals must be shielded and grounded.

Operation with cables, connected to peripherals, that are not shielded and grounded, may result in interference to radio and television reception.

FCC Part 68

This equipment complies with Part 68 of the FCC rules. The ringer equivalence number (REN) and the FCC registration number are printed on the modem board. If requested, this information must be supplied to the telephone company.

The REN is used to determine the quantity of devices which may be connected to the phone line. Excessive REN's on the telephone line may result in the devices not ringing in response to an incoming call. In most, but not all areas, the sum of the REN's should not exceed five (5.0). To be certain of the number of devices that may be connected to the line, as determined by the total REN's, contact the telephone company to determine the maximum REN for the calling area.

This modem uses the USOC RJ-11 telephone jack.

If this equipment causes harm to the telephone network, the telephone company will, when practical, notify you in advance that temporary discontinuance of service may be required. If advance notice isn't practical, the telephone company will notify you as soon as possible. Also, you will be advised of your right to file a complaint with the FCC if you believe it is necessary.

The telephone company may make changes in its facilities, equipment, operations or procedures that could affect the operations of the equipment. If this happens, the telephone company will notify you in advance, in order for you to make the necessary modifications in order to maintain uninterrupted service.

If trouble is experienced with this modem, for repair or warranty information, please contact 1-888-4SONYPC, or write to the Sony Customer Information Center, One Sony Drive, Park Ridge, NJ 07656.

This equipment cannot be used on telephone-company-provided coin service. Connection to Party Line Service is subject to state tariffs.

Repair of the modem should be made only by a Sony Service Center or Sony authorized agent. For the Sony Service Center nearest you, call 1-800-222-SONY (1-800-222-7669).

Telephone Consumer Protection Act of 1991

The Telephone Consumer Protection Act of 1991 makes it unlawful for any person to use a computer or other electronic device to send any message via a telephone facsimile machine unless such message clearly contains, in a margin at the top or bottom of each transmitted page or on the first page of the transmission, the date and time it is sent and an identification of the business, other entity, or individual sending the message, and the telephone number of the sending machine or such business, other entity, or individual.

In order to program this information into your facsimile, see your fax software documentation.



You are cautioned that any changes or modifications not expressly approved in this manual could void your authority to operate this equipment.

Contents

Notice to Users	ii
Safety Information	ii
Regulatory Information.....	iii
FCC Part 68	iv
Telephone Consumer Protection Act of 1991.....	iv

Chapter 1 — Identifying Components

Front View	2
Drives	3
Buttons and Switches	4
Indicators	5
Rear View	6
Icons	7
I/O Connectors	9
Expansion Slots	13

Chapter 2 — Configuring Your System

Accessing the BIOS Setup Utility	16
Changing the Display's Power-management Settings	17
Configuring the System Board	18

Chapter 3 — Removing, Installing, and Replacing Components

Removing the Left Side Panel	22
Removing the Bottom Panel.....	23
Removing the Front Panel	24
Replacing the Front Panel.....	25
Replacing the Bottom Panel	26

Replacing the Left Side Panel	27
Installing an Add-In Card	28
Removing an Add-in Card	29
Replacing the Lithium Battery	31
Installing System Memory	34
Removing a Memory Module	37
Detaching the Diskette Drive	39
Removing a Slot Cover	40
Covering an Open I/O Slot	41
Installing an Internal Hard Disk Drive	42

Chapter 4 — System Board

Connectors.....	48
Front Panel Header.....	48
Diskette Drive Connector	49
Memory Module (DIMM) Connectors	50
Slot Connectors.....	51
IDE Connectors	53
Power Connector	54
Optional Keyboard and Mouse Connectors	55
USB Connectors	56
Serial, Printer, and Monitor Connectors	57
Fan Connectors	60
Game Connector.....	61
Headphones, Line In, Mic Connectors.....	62
Ring Connector.....	63
Modem In Connector	64
CD In Connector	65
TV Out Connector.....	66
Configuration Jumpers	67
CPU Speed	67
Clear Password and BIOS Recovery	68

Chapter 5 — TV-Out Paddle Card

Connectors	70
------------------	----

Chapter 6 — Fax/Modem Card

Connectors72

Chapter 7 — BIOS Setup Options

Main Screen75
Advanced Screen80
Security Screen.....83
Power Screen.....84
Boot Screen86
Exit Screen87

Chapter 8 — Miscellaneous Technical Information

About User and Supervisor Passwords90
Beep Code Error Messages91
PCI Configuration Status And Error Messages92
DMA Channel Assignments94
IRQ Assignments95
System I/O Address Map96
Memory Map98

Chapter 9 — Specifications

Processor99
Memory Modules (DIMMs)99
DIMM Configurations99
L2 Cache99
Graphics100
Video100
Audio100
Communications100
I/O and Expansion Slots101
Drives and Controllers101
BIOS101

Power Supply102
CPU Environment102

Chapter 1

Identifying Components

The following sections identify and describe each component that is visible from the exterior of the VAIO MicroTower. Internal components are identified in the appropriate section of this manual.

Front View

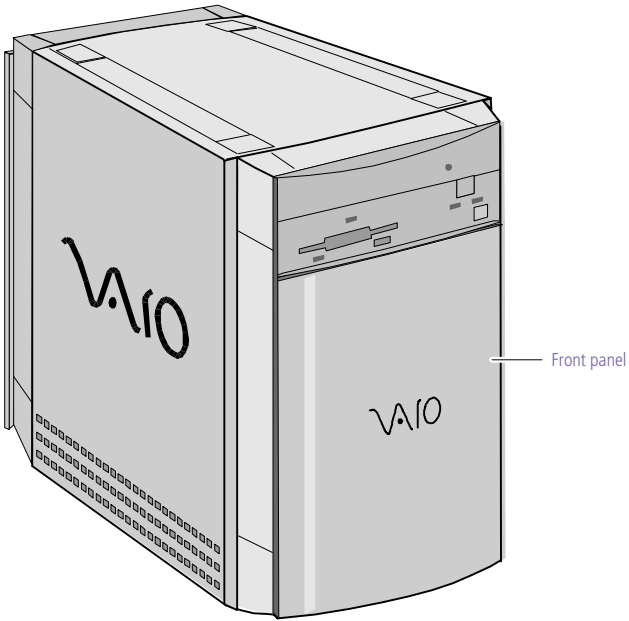

OM04694X.VSD

Drives

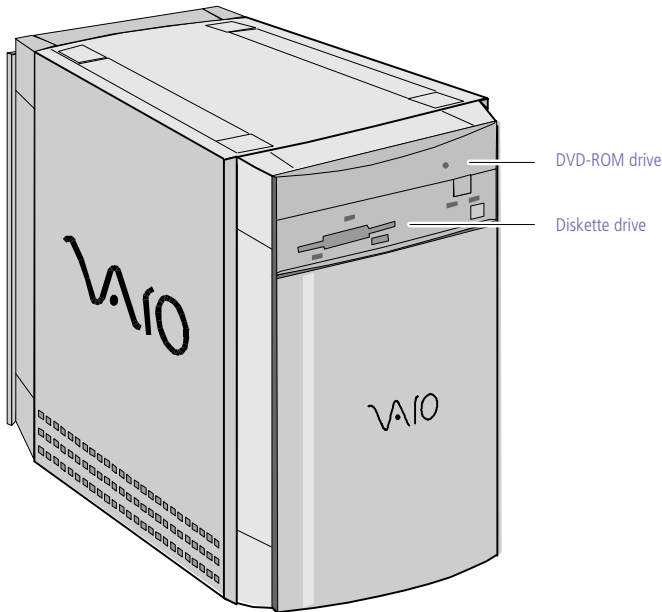

FNRPNL.A.VSD

Drive	Description
Diskette drive	3.5-inch, 1.44 Mbyte.
DVD-ROM drive	DVD-ROM disc: 4X (maximum performance). [*] CD-ROM disc: 24X (maximum performance). [*]

^{*} DVD-ROM drive also plays CD-ROM discs. Data on the DVD-ROM is read at a variable transfer rate, ranging from 2X at the innermost track to 4X at the outermost track (the data transfer standard 1X rate is 1385 kbytes/s). The average data transfer rate is 3.3X (4616 kbytes/s). Data on a CD-ROM disc is read at a variable transfer rate, ranging from 10X at the innermost track to 24X at the outermost track (the data transfer standard 1X rate is 150 kbytes/s). The average data transfer rate is 17X (2250 kbytes/s).

Buttons and Switches

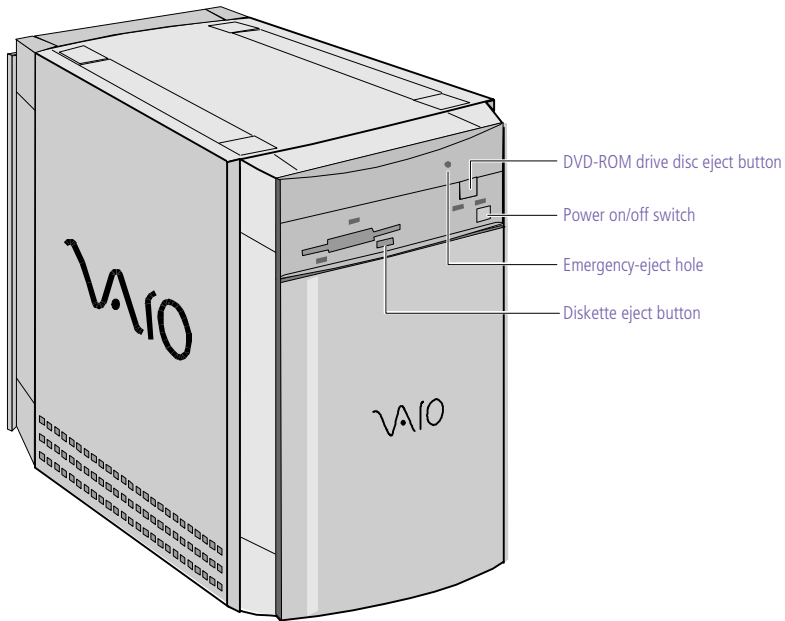

FNRTPNLB.VSD

<i>Button or switch</i>	<i>Description</i>
Power on/off switch	Turns system power on and off.
Diskette eject button	Ejects a diskette.
DVD-ROM disc eject button	Automatically opens and closes the DVD-ROM tray.
Emergency-eject hole	Ejects a DVD-ROM disc or CD-ROM disc.

Indicators

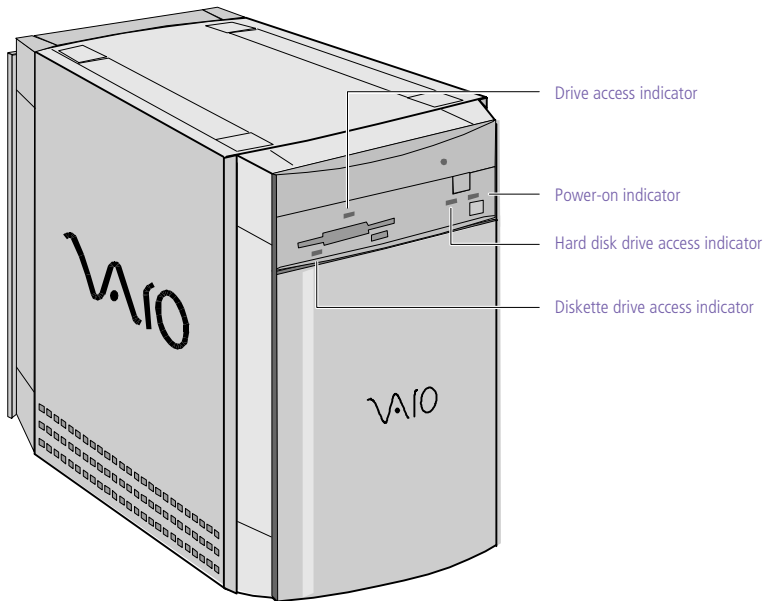

FRNTPNLD.VSD

<i>Indicator</i>	<i>Description</i>
Power-on indicator	On (amber) indicates the computer is in standby mode. On (green) indicates the computer is out of standby mode, ready to use. Off (no color) indicates the computer is turned off.
Diskette drive access indicator	On (green) indicates diskette drive activity.
DVD-ROM drive access indicator	On (orange) indicates DVD-ROM disc or CD-ROM activity.
Hard disk drive access indicator	On (orange) indicates hard disk drive activity.



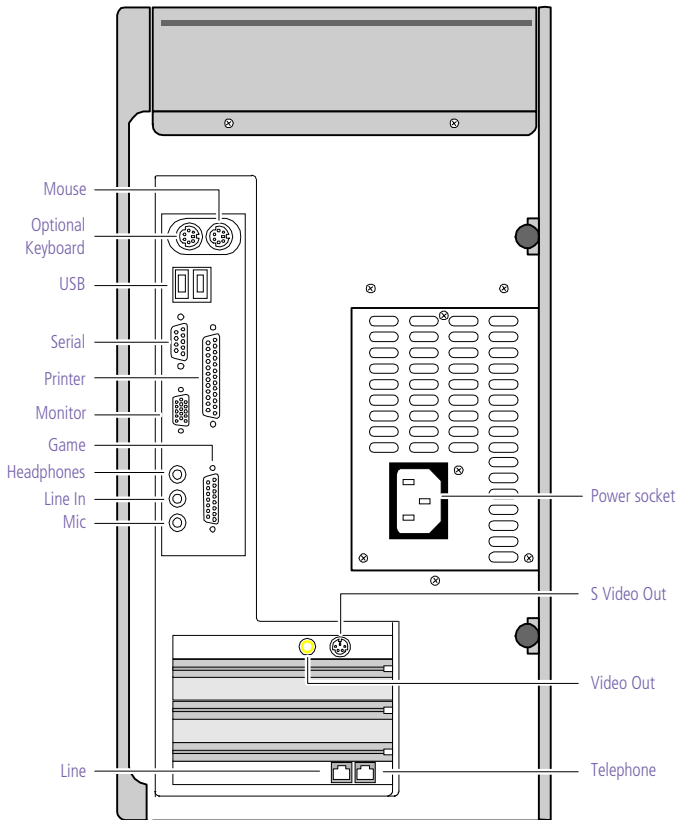



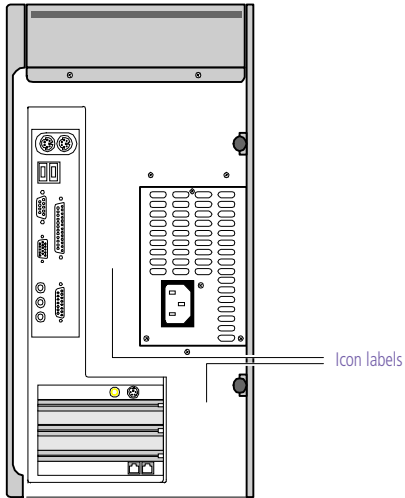



Rear View





Icons



OM04692X.VSD

<i>Icon</i>	<i>Description</i>
	Mouse connector
	Optional Keyboard connector
	Universal Serial Bus (USB) connectors
	Serial port connector
	Printer port connector
	Game/MIDI port connector
	Headphones
	Line In jack (audio)
	Microphone jack
	S Video Out jack
	Video Out jack

<i>Icon</i>	<i>Description</i>
	Monitor connector
	Line (for telephone line from primary service jack)
	Telephone (for phone)

I/O Connectors

The following section identifies the various I/O connectors.

Optional Keyboard and Mouse

The keyboard and mouse connectors are physically identical and have the same pinout. They are standard 6-pin PS/2-type female connectors.

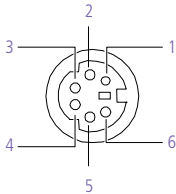

KY0002.VSD

USB Ports

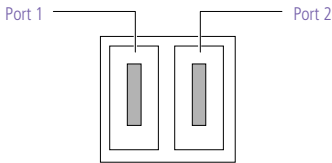

KY0003.VSD

Serial Port

The serial port is a standard 9-pin DB-9 male connector.

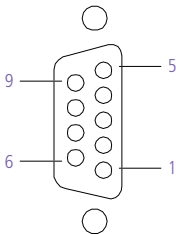

KY0057.VSD

Printer Port

The printer port is a standard 25-pin DB-25 female connector.

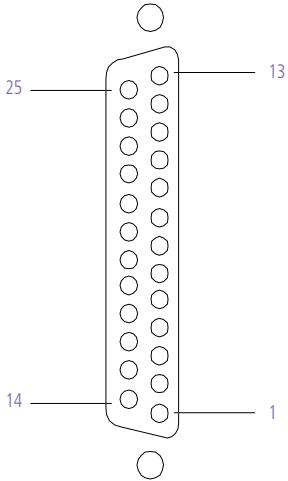

KY0005.VSD

S Video Out

The S Video Out connector is a standard 4-pin S Video jack.

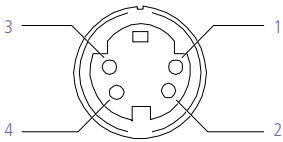

KY0006.VSD

Video Out

The Video Out jack is for composite video. It is a standard RCA phono jack.

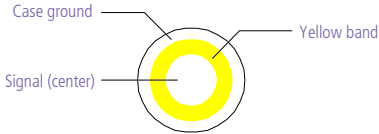

KY0007.VSD

! Do not plug video cables into the wrong connectors, as this may damage the video card in the computer and the equipment to which it is connected.

Monitor

The Monitor connector is a standard 15-pin female high-density VGA-type connector.

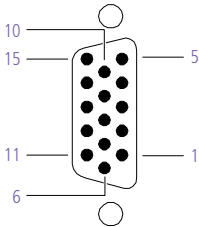

KY0004.VSD

Game Port

The Game port is a standard 15-pin DB-15 female connector. This port is also used to connect MIDI devices.

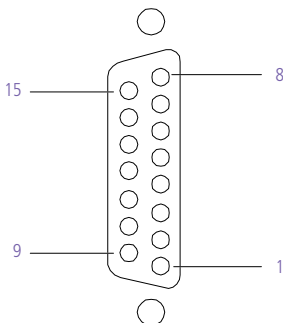

KY0012.VSD

Mic, Line In, and Headphones

The Mic, Line In, and Headphones jacks are physically identical, but have different connections. They are standard 3.5 mm stereo mini-jacks.

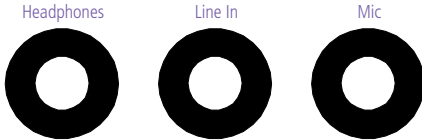

KY0013.VSC

<i>Connector</i>	<i>Description</i>
Headphones	1.0 Vrms (typical)
Mic	Electrolet condenser microphone input
Line In	1.0 Vrms (typical), 10 Kohm impedance

Telephone and Line

The Telephone and Line jacks are physically identical and have identical connections. They are standard RJ-11 female phone jacks. However, the Line jack is for connecting to a telephone line that comes from the wall, and the Telephone jack is for connecting the computer to a telephone.

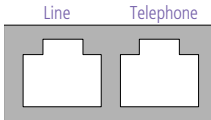

KY0014.VSD

 Accidentally plugging a phone line from the wall into the modem's Telephone jack, and a telephone into the Line jack, will not damage the modem card or telephone equipment. However, the modem may not work correctly.

Expansion Slots

Two dedicated PCI slots are available for expansion. The ISA slot is occupied by the fax/modem card.

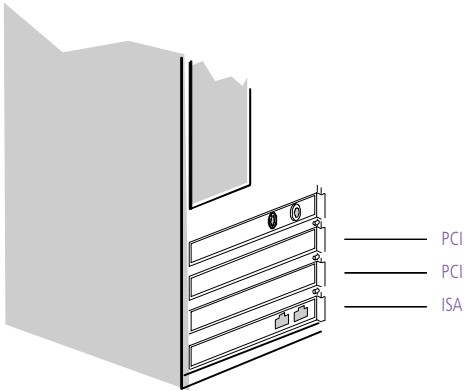

OM04577B.VSD

Chapter 2

Configuring Your System

This chapter contains information on configuring your system. Configuring your system can consist of the following:

- ❑ Making changes to the BIOS settings
- ❑ Making changes to the display's power management settings
- ❑ Changing the system board jumper position

Accessing the BIOS Setup Utility

You must access the BIOS Setup Utility to make changes to the BIOS settings (see “BIOS Setup Options” on page 73 for information on BIOS settings).

! Before rebooting the system, save any open files and exit Windows®.

- 1 Reboot the system. The following message appears during the initial boot sequence:

Press <F3> for Boot screen

- 2 Press F3. The following message appears.

Press <F2> for setup.

- 3 Press F2.

Each menu presents options for modifying the system configuration. Use the left and right arrow keys to select a menu from the menu bar. Use the up and down arrow keys to select items within a menu. Once an item is highlighted, use the plus/minus (+/-) keys to modify a setting.

If an item has a triangle (▶) to its left, this indicates that a sub-menu of options is available. Press ENTER to access a sub-menu. If a sub-menu contains items with a triangle, there is another layer of options from which to select.

- 4 Once you select an option, press ESC to back out of each menu until you reach the top level, where the menu bar appears.
- 5 To exit the BIOS setup utility, press ESC from any top-level screen and follow the prompts.

Changing the Display's Power-management Settings

A display that has power management capability is designed to operate on reduced power or shut itself off after the system has been idle for a specified period of time.

- 1 From the **Start** menu, point to **Settings**, then click **Control Panel**.
- 2 Double-click the **Display** icon.
- 3 Click the **Screen Saver** tab.

If your display is Energy-Star compliant or has other energy-saving features, the Energy saving features of the monitor dialog box appear. Otherwise, the options in the dialog box are grayed out.

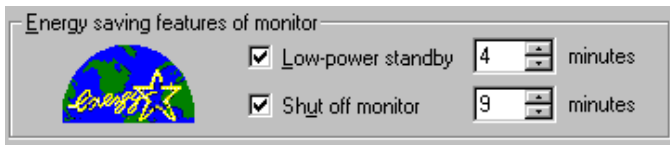

OM05228.VSD

- 4 Select **Low-power standby** or **Shut off monitor**.

Selecting **Low-power standby** blanks the screen (similar to a screen saver) and automatically reduces power to the display after a specified amount of time. The display reactivates when you move the mouse or press a key.

Selecting **Shut off monitor** automatically turns off the display if the system has been idle for a specified amount of time. Power is reactivated when you move the mouse or press a key.

- 5 Select the number of minutes to wait between the last keyboard or mouse activity and activation of the power-management settings.

Configuring the System Board

The system board contains two configuration jumpers that provide three modes of operation: Normal mode, Clear Password mode, and BIOS Recovery mode.

Normal mode allows normal access to the BIOS Setup Utility. The Central Processing Unit (CPU) input clock is forced to remain at 66 MHz (fast mode), and the Basic Input/Output System (BIOS) uses the User CMOS settings (as opposed to the System CMOS settings). The CMOS and NVRAM settings are only cleared if the checksum test returns false. Access to specific setup fields is controlled by a supervisor password or user password.

Clear Password mode removes the password that is stored in CMOS.

BIOS Recovery mode sets the CPU input clock to 66 MHz (fast mode) and attempts to perform a blind BIOS update.



The configuration jumpers should never need changing unless otherwise directed by a technical support or service technician.

! Before opening the system, save any open files, exit Windows, turn off the power of the computer and all attached peripherals, and unplug the power cord.

- 1 Remove the side panel (see “Removing the Left Side Panel” on page 22).
- 2 Remove the bottom panel (see “Removing the Bottom Panel” on page 23).

- 3 Set the jumpers as directed by a service technician (also see “Configuration Jumpers” on page 67).

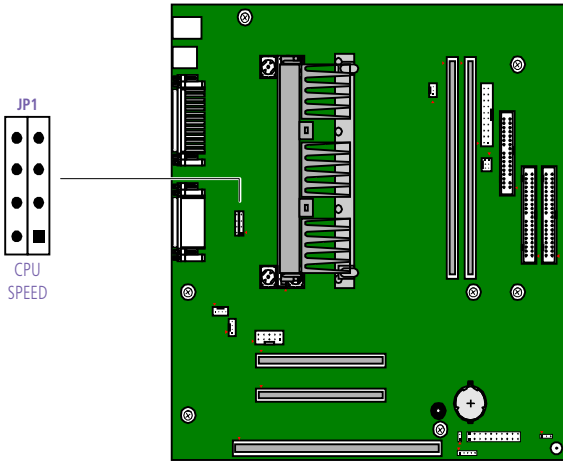

OM04588.VSD

- 4 Reinstall the bottom panel (see “Removing the Bottom Panel” on page 23).
- 5 Reinstall the side panel (see “Replacing the Left Side Panel” on page 27).

Chapter 3

Removing, Installing, and Replacing Components

This chapter describes removing, installing, and replacing major components for upgrading, reconfiguring, replacing, or troubleshooting the components.

! Before opening the system unit, save any open files, exit Windows, turn off the power of the computer and all attached peripherals, and then unplug the power cord.

Removing the Left Side Panel

You must remove the left side panel to access the system board, add-in cards, power supply, battery, and internal drives.

- 1 From the rear of the unit, remove the two thumb screws that secure the panel to the chassis.
- 2 Slide the left side panel back with your right hand as you hold the chassis in position with your left hand. The panel slides back about $\frac{1}{2}$ inch.

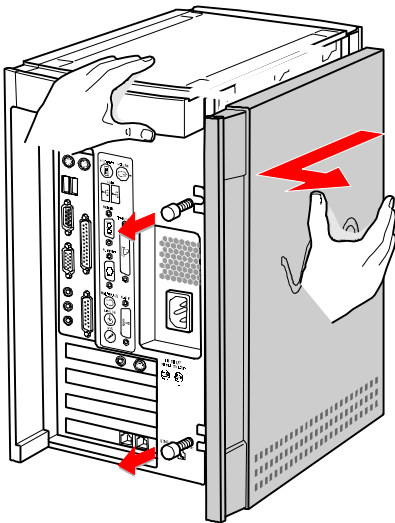

KY0064.VSD

- 3 Pull the panel straight out to remove it.

Removing the Bottom Panel

You must remove the bottom panel to access internal components.

- 1 Remove the left side panel (see “Removing the Left Side Panel” on page 22).
- 2 Remove the screw that secures the bottom panel to the chassis.

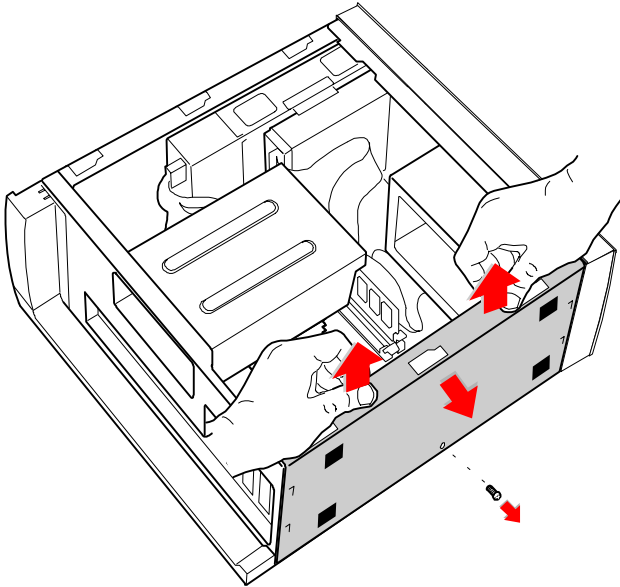

KY0065.VSD

- 3 Pull up on the bottom panel until it stops. The panel moves up about $\frac{1}{2}$ inch.
- 4 Pull the panel straight out to remove it.

Removing the Front Panel

You must remove the front panel to install system memory, which requires pulling the diskette drive out about two inches.



Follow steps 1 to 3 in the sequence shown to prevent damage to the front tray cover.

- 1 Insert a straightened paper clip into the emergency-eject hole to open the tray.
- 2 Pull the tray out to its normal opened position.
- 3 Lift up on the front tray cover to remove it.
- 4 Push the tray back in.
- 5 Remove the bottom panel (see “Removing the Bottom Panel” on page 23) to access the two plastic tabs on the bottom of the front panel.
- 6 Push down and out on the two plastic tabs from inside the bottom of the chassis to release the bottom end of the front panel.

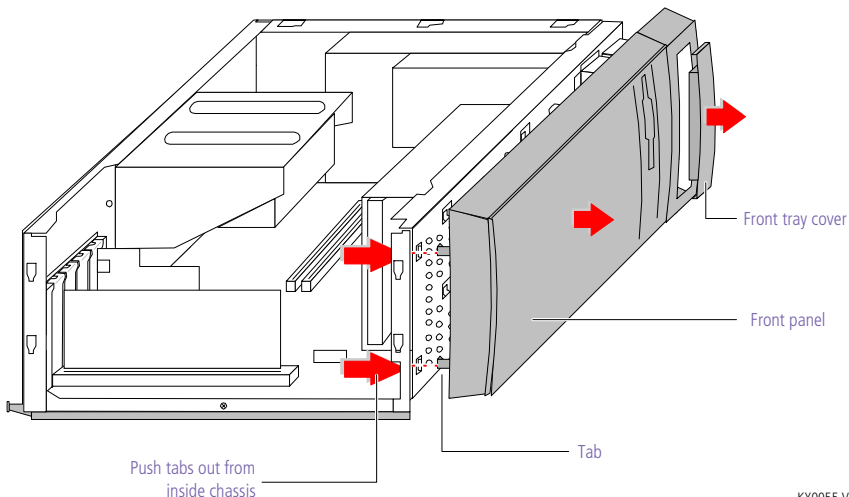

KY0055.VSD

- 7 Pull out the top end of the front panel to remove it.

Replacing the Front Panel

- 1 Insert the two plastic tabs (located on the bottom of the front panel) into the slots at the bottom of the chassis.
- 2 Push the bottom of the front panel in until the tabs snap into place.
- 3 Push the top of the front panel until it is flush with the chassis.
- 4 Insert a straightened paper clip into the emergency-eject hole to open the tray.
- 5 Pull the tray out to its normal opened position.
- 6 Carefully slide the tray cover down onto the CD-/DVD-ROM tray, then slide the tray in.

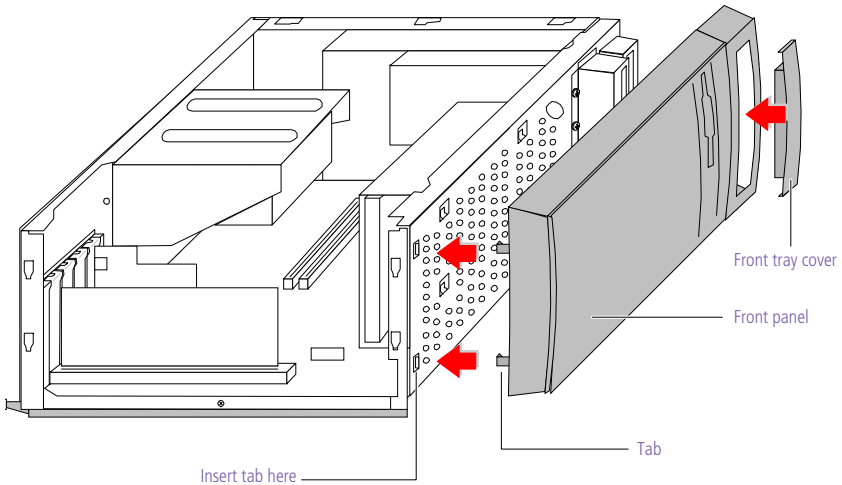

Replacing the Bottom Panel

- 1 Lay the chassis down with the open side facing up and the bottom end facing you. The arrows show the location of the slots.

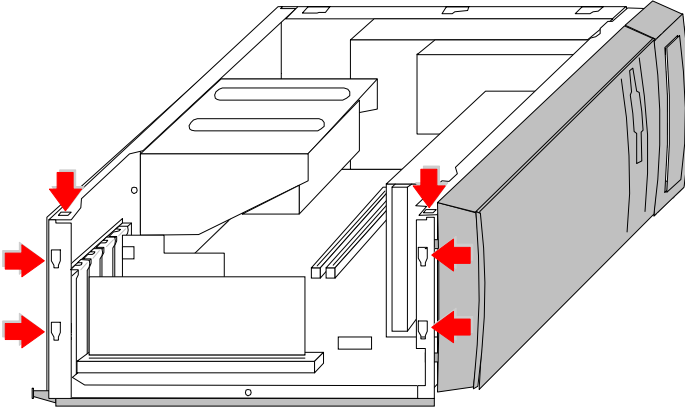

KY0078.VSD

- 2 Position the bottom panel up against the bottom of the chassis, with the top of the panel about $\frac{1}{2}$ inch higher than the chassis.

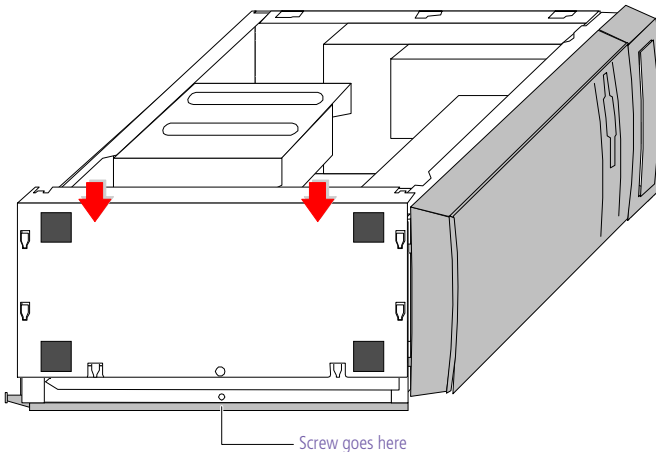

KY0079.VSD

- 3 Slide the bottom panel down until the panel's tabs slide into the chassis's slots. Push down firmly until the screw hole in the chassis aligns with the screw hole in the panel.
- 4 Replace the screw (removed earlier) to secure the bottom of the panel to the chassis.

Replacing the Left Side Panel

- 1 Position the left side panel against the side of the unit, with the left side panel offset from the rear of the unit by about $\frac{1}{4}$ to $\frac{1}{2}$ inch.
- 2 Hold the unit in position with your left hand as you slide the left side panel forward with your right hand until the panel snaps into place.

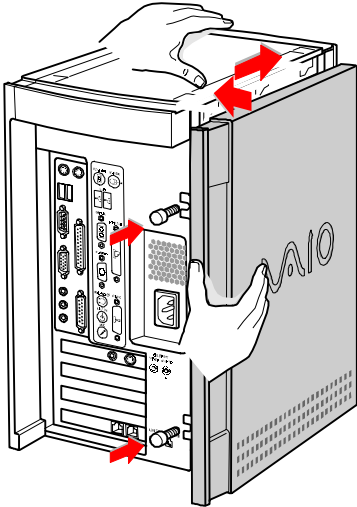

KY0067.VSD

- 3 Insert the two thumbscrews (removed earlier) to secure the panel.

Installing an Add-In Card

! Before opening the system unit, save any open files, exit Windows, turn off the power of the computer and all attached peripherals, and then unplug the power cord.

- 1 Remove the slot cover adjacent to the selected slot connector on the system board (see “Removing a Slot Cover” on page 40).
- 2 Insert the add-in card into the PCI slot connector. Use a gentle rocking motion, pressing down until the card is fully seated.

 Align the card's bracket so that the bottom of the bracket fits into the slot at the bottom of the chassis. Assume that the top of the bracket fits snugly against the chassis lip after the card is fully inserted.

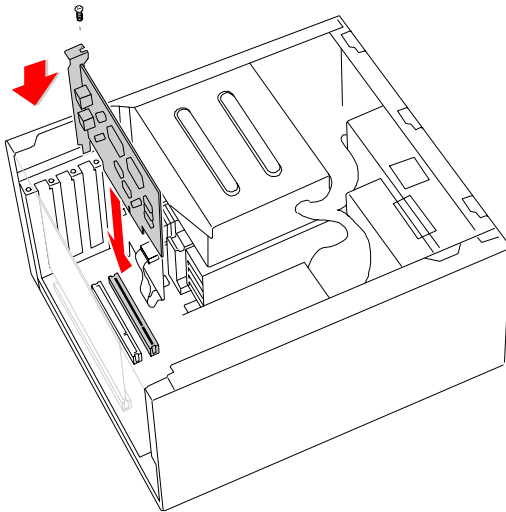

KY0070.VSD

- 3 Attach any necessary cables to the card (see the instructions that came with the add-in card).
- 4 Replace the bottom panel (see “Replacing the Bottom Panel” on page 26).
- 5 Replace the left side panel (see “Replacing the Left Side Panel” on page 27).
- 6 Turn on the computer and follow any instructions that came with the add-in card.

Removing an Add-in Card

! Before opening the system unit, save any open files, exit Windows, turn off the power of the computer and all attached peripherals, and then unplug the power cord.

- 1 Remove the left side panel (see “Removing the Left Side Panel” on page 22).
- 2 Remove the bottom panel (see “Removing the Bottom Panel” on page 23).
- 3 Disconnect any cables attached to the add-in card.
- 4 Remove the screw that secures the add-in card to the chassis.
- 5 Remove the add-in card from the PCI slot connector and store the card in an anti-static wrapper for future use.

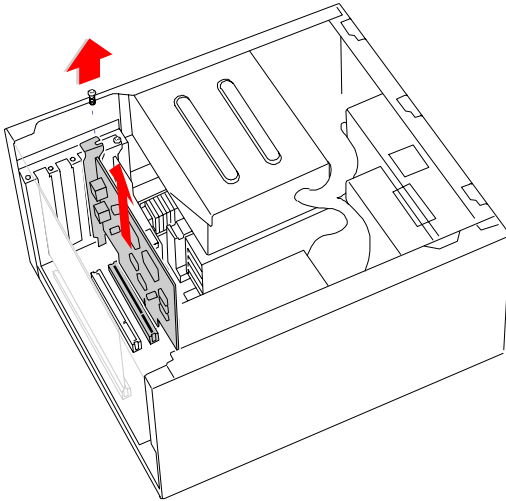

KY0071.VSD

 Grasp the card with one hand on each end, and gently pull up as you rock the card from side to side.

! Hold the add-in card by its edges and do not touch any components or connector contacts on the card. Static electricity in your body may damage sensitive components on the card. As a precaution, touch any exposed metal part on the metal chassis (preferably the metal part on the power supply) before handling an add-in card to discharge any static electricity in your body.

- 6 If you do not replace the card or install another add-in card, install a slot cover over the vacant slot at the rear of the chassis (see [“Covering an Open I/O Slot”](#) on page 41).
- 7 Replace the bottom panel (see [“Replacing the Bottom Panel”](#) on page 26).
- 8 Replace the left side panel (see [“Replacing the Left Side Panel”](#) on page 27).

Replacing the Lithium Battery

You may need to replace the lithium battery if your computer consistently loses the date or time settings after turning it off. The lithium battery has a typical life of three years, after which the battery may be too weak to power the CMOS memory.

! When you remove the lithium battery, all values stored in the CMOS memory (BIOS setup values and Plug and Play values) may be lost. Although the computer can hold the charge for a short time while replacing the battery, it is safer to assume that the settings will be lost. When the values are lost, the BIOS values revert to their factory-default settings (see “[Accessing the BIOS Setup Utility](#)” on page 16).

Do not handle damaged or leaking batteries.

The lithium battery may explode if mistreated. Do not disassemble it or dispose of it in fire.

- 1 Reboot your computer by selecting Shut Down... from the Start menu, and then selecting Restart the computer.
- 2 If the error message “Error: Check date and time settings” appears during the reboot sequence, press F3, then press F2 during the reboot process to access the BIOS Setup Utility. Otherwise it is not necessary to replace the battery at this time, and you can skip all remaining steps.
- 3 Compare all the BIOS options to their default settings (see “[BIOS Setup Options](#)” on page 73). Make a list of all the BIOS options that are different from their default values. You will refer to this list when you restore the BIOS settings later.
- 4 Press ESC, then select Exit from the main menu using the right arrow key. The Exit Discarding Changes is automatically selected (it is the first item in the list).
- 5 Press Enter, type N when prompted to save, then press Enter to exit the BIOS Setup Utility.
- 6 Turn off the computer and unplug the power cord.
- 7 Remove the left side panel (see “[Removing the Left Side Panel](#)” on page 22).
- 8 Remove the bottom panel (see “[Removing the Bottom Panel](#)” on page 23).

- 9 If necessary, remove any add-in cards (see “[Removing an Add-in Card](#)” on page 29) to gain access to the battery. You may also need to disconnect some cables.

! Touch any exposed metal part of chassis to discharge static electricity in your body before handling an add-in card or other sensitive electronic component.

- 10 Insert a small flathead screwdriver into the small space at the top of the battery holder.

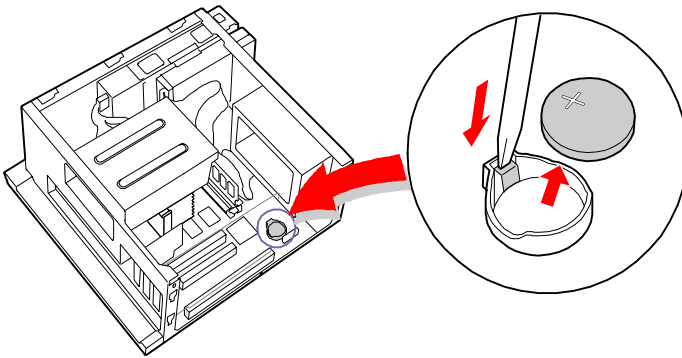

KY0072.VSD

- 11 Gently pry the battery out and dispose of it according to the instructions that came with the new battery.
- 12 Insert the new battery into the battery holder, with the plus (+) side up.



The Sony CR2032 battery is recommended. Using a type of battery other than a CR2032 may present a risk of fire or explosion.

- 13 Replace any add-in cards that were removed.
- 14 Reconnect any cables that were disconnected.
- 15 Replace the bottom panel (see “[Replacing the Bottom Panel](#)” on page 26).
- 16 Replace the left side panel (see “[Replacing the Left Side Panel](#)” on page 27).
- 17 Reconnect the power cord and turn on the computer.

- 18 If the error message “Error: Check date and time settings.” appears during the reboot sequence, press F3, then press F2 to access the BIOS Setup Utility. If no error message displays, the computer’s BIOS settings were retained during the battery replacement and you can skip the remaining steps.
- 19 Refer to the list you made in step 3 and restore any non-default BIOS settings (see “[BIOS Setup Options](#)” on page 73).
- 20 Press ESC, then select Exit from the main menu using the right arrow key.
- 21 Select Exit Saving Changes using the down arrow key, then press Enter to save the changes and exit the BIOS Setup Utility.

The computer’s BIOS settings are now restored.

Installing System Memory

! Before opening the system unit, save any open files, exit Windows, turn off the power of the computer and all attached peripherals, and then unplug the power cord.

- 1 If necessary, remove the memory module you wish to replace (see “Removing a Memory Module” on page 37).
- 2 Remove the new memory module(s) from its anti-static package. Hold the memory module only by its edges to prevent static-electricity damage.
- 3 Choose the size of the memory module and configuration as shown in the following table. Memory modules can vary in size and speed between sockets. The minimum memory size is 8 MB; the maximum memory size is 256 MB. The BIOS automatically detects the type, size and speed of the memory modules.

Memory module configurations (MB)*

<i>Bank 0</i>	<i>Bank 1</i>
0, 8, 16, 32, 64, 128	0, 8, 16, 32, 64, 128

* The PCV-E204 is shipped with 64 MB.

! Touch any exposed metal part of the chassis to discharge static electricity in your body before handling a memory module.

- 4 Align the module over the appropriate socket, noting the location of pin 1 on the module and pin 1 on the socket.

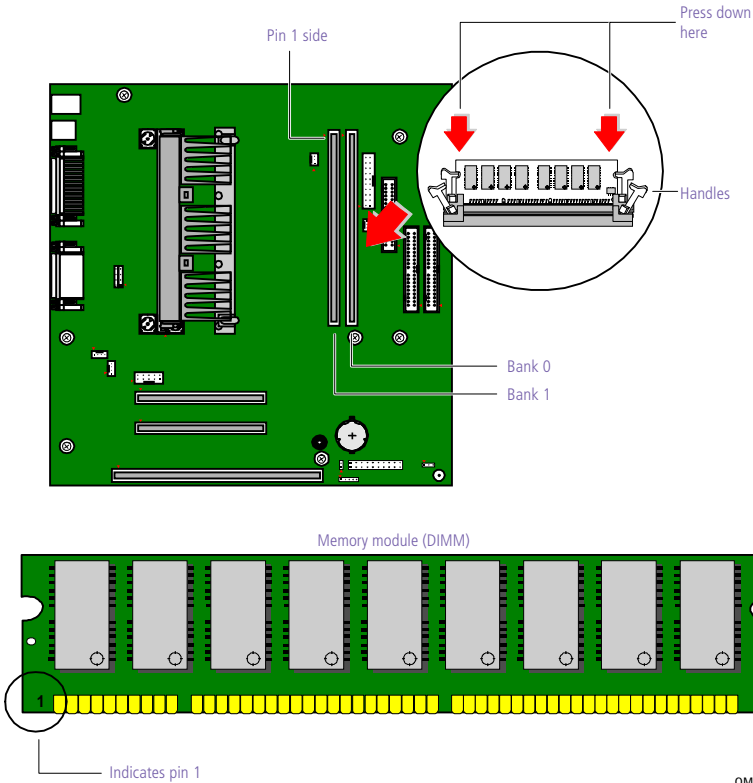

- 5 Carefully but firmly insert the edge of the module into the socket.
- 6 Press down firmly and evenly at both corners until the module is fully seated.

 When the module is fully seated, the handles on each side are straight up and locked into the slot on each side of the module. If the handles are not totally straight upright, continue to press down on each side of the module until the handles lock into place.

- 7 Replace any add-in cards and other components that were removed.
- 8 Replace the bottom panel (see [“Replacing the Bottom Panel”](#) on page 26).

- 9 Replace the front panel (see “Replacing the Front Panel” on page 25).
- 10 Replace the left side panel (see “Replacing the Left Side Panel” on page 27).

Your computer automatically recognizes the extra memory and will configure itself accordingly when you turn it on. No further action is required.

Removing a Memory Module

You may need to remove a memory module if you change the memory configuration or replace a bad module.

! Before opening the system unit, save any open files, exit Windows, turn off the power of the computer and all attached peripherals, and then unplug the power cord.

- 1 Remove the left side panel (see “Removing the Left Side Panel” on page 22).
- 2 Remove the bottom panel (see “Removing the Bottom Panel” on page 23).
- 3 Remove the front panel (see “Removing the Front Panel” on page 24).
- 4 Slide the diskette drive out approximately two inches (see “Detaching the Diskette Drive” on page 39).
- 5 Remove any add-in cards (see “Removing an Add-in Card” on page 29) and other components as needed to access the memory modules.
- 6 Locate the memory module you wish to remove.

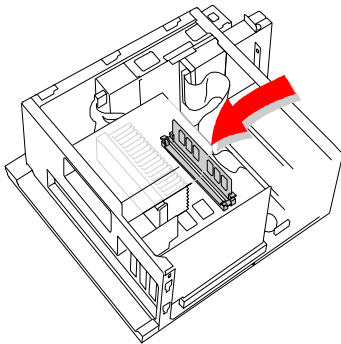

- 7 Push out the handle on each side of the memory module to eject the module from its socket.

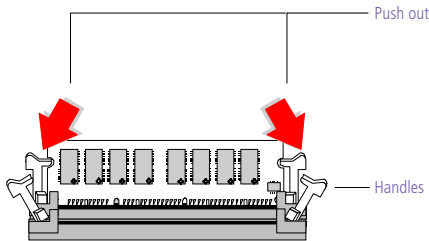

KY0042.VSD

- 8 Lift the memory module out by grasping it by its edges. Store the module in a static-free bag.

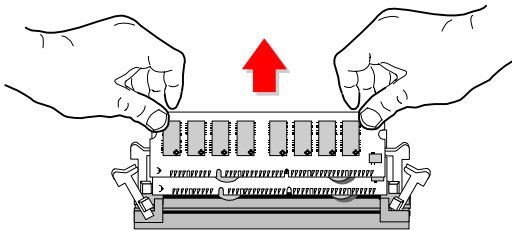

KY0043.VSD

! Touch any exposed metal part of the chassis to discharge static electricity in your body before handling the memory module.

Detaching the Diskette Drive

You need to detach the diskette drive and pull it out approximately two inches to access the system memory.

- 1 Remove the two screws that secure the diskette drive carrier to the chassis.

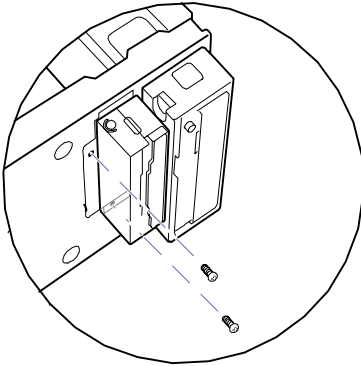

KY0074.VSD

- 2 Slide the diskette drive carrier out approximately two inches (enough to provide access to the memory modules).



Be careful not to hook the plastic LED and power-switch cover when sliding the diskette drive in or out. The metal tab on the diskette drive may come close to the plastic cover. If the plastic cover is accidentally removed, reattach it by inserting the plastic tabs into the slots in the chassis.

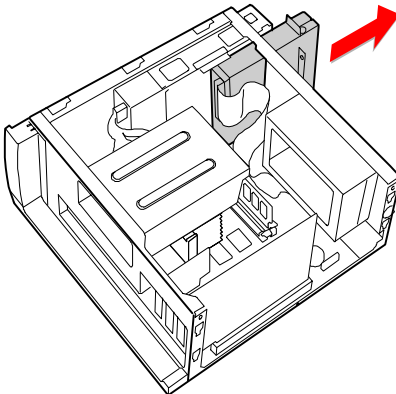

KY0075.VSD

- 3 Unplug the flat ribbon cable and power connector (P4), as needed.

Removing a Slot Cover

You remove a slot cover when you install an add-in card that occupies a previously-empty slot.

- 1 Locate the slot of the cover you want to remove.
- 2 Remove the left side panel (see “[Removing the Left Side Panel](#)” on page 22).
- 3 Lay the system on its side with the open side facing up.
- 4 Carefully remove the screw from the slot cover.
- 5 Carefully remove the loose slot cover and retain it for future use.

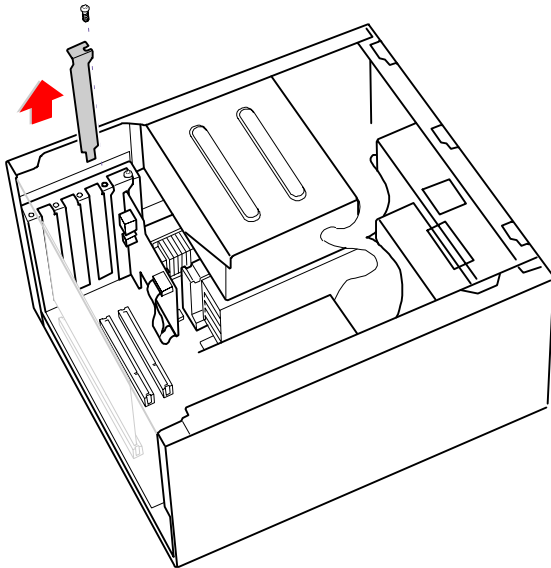

Covering an Open I/O Slot

Slot covers prevent air from escaping through the empty hole. If air escapes, the components inside the computer cannot be properly cooled. This may damage some components, especially the main processor (which generates the most heat).

- 1 Fit the tip of the slot cover (removed earlier) between the chassis and system board.

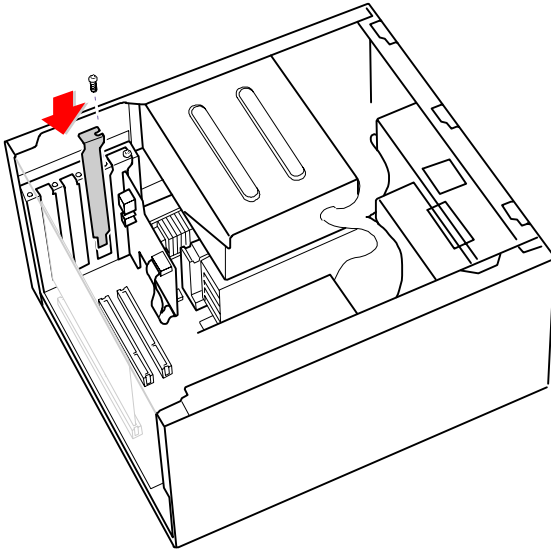

KY0076.VSD

- 2 Push the slot cover down until it rests firmly on the lip in the chassis. All add-in card brackets and slot covers rest on this lip.
- 3 Replace the screw (removed earlier) to secure the I/O slot cover.

Installing an Internal Hard Disk Drive

Your system comes with an available bay to hold an additional hard disk drive. The drive you install must not require front panel access. The hard disk drive access light blinks when either internal drive is active.

! Before opening the system unit, save any open files, exit Windows, turn off the power of the computer and all attached peripherals, and then unplug the power cord.

- 1 Configure the jumpers on the new drive as a secondary master (see your drive's documentation for configuration instructions).

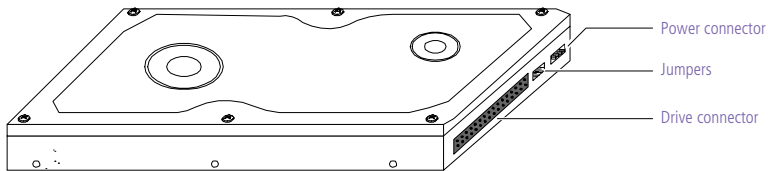

KY0084.VSD

- 2 Remove the left side panel (see “Removing the Left Side Panel” on page 22).
- 3 Remove the front panel (see “Removing the Front Panel” on page 24).
- 4 Remove the bottom panel (see “Removing the Bottom Panel” on page 23).
- 5 Lay the system on its right side (left side faces up – see diagram that follows).
- 6 Remove the two screws (A) that secure the drive holder.

- Slide the drive holder forward (B), and then out (C).

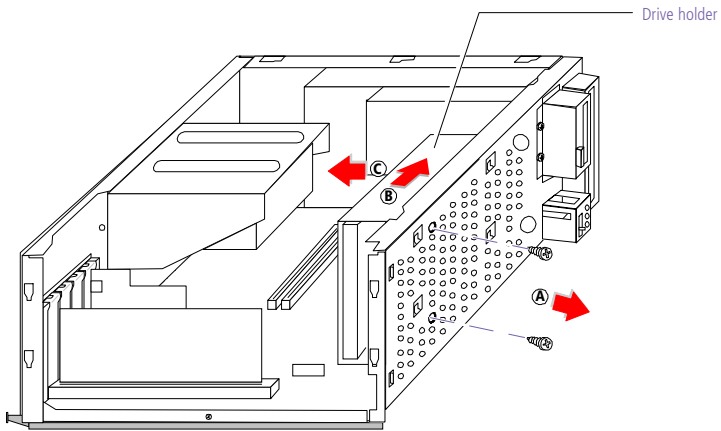

KY0081.VSD

- Place the drive holder upside down on top of the power supply.

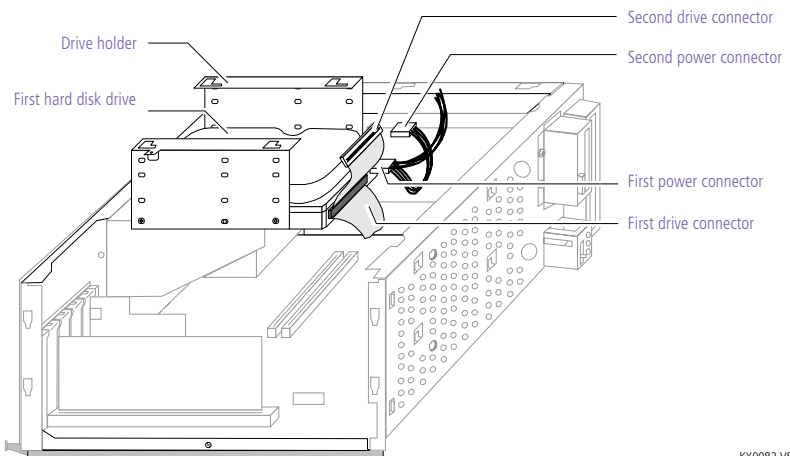

KY0082.VSD

- 9 Slide the new drive into the drive holder and align the holes on each side of the drive bay.

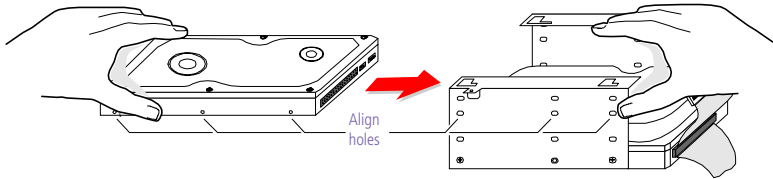

KY0083.VSD

- 10 Secure the drive to the drive holder using any two of the three holes on each side of the drive holder (screws are provided with the new drive). Do not overtighten the screws.
- 11 Connect the second drive connector to the new drive.
- 12 Connect the second power connector to the new drive.

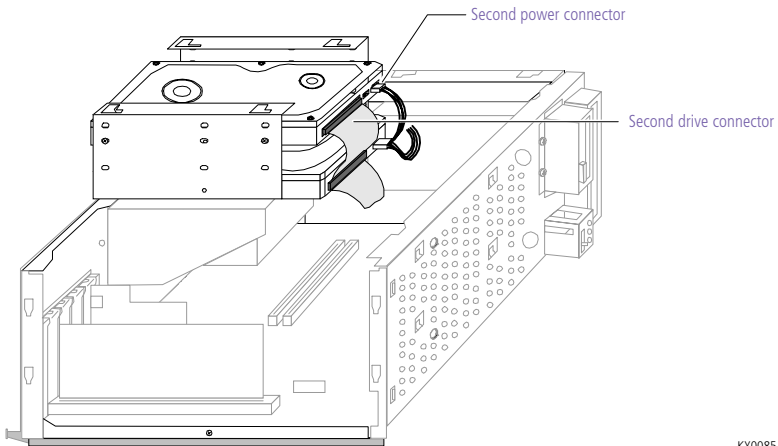

KY0085.VSD

- 13 Place the drive holder against the inside of the front chassis and slide the drive holder back. Be sure to align the slots (A) on the drive holder with the tabs (B) on the inside of the chassis. Be sure to slide

the drive holder back so that the tabs slip into the notches at the bottom of the slot (C).

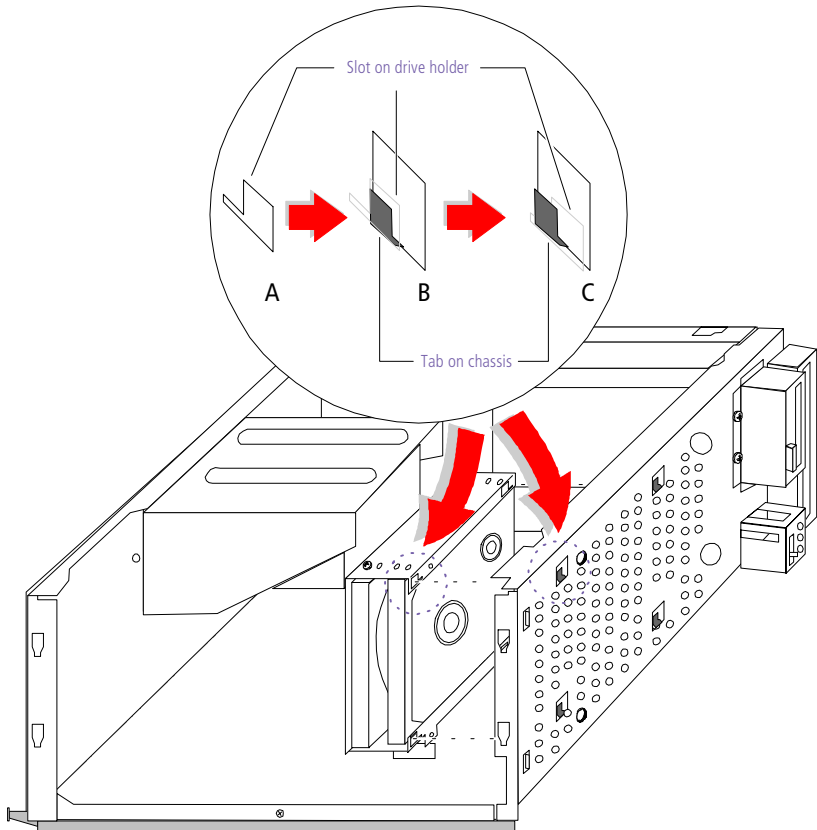

KY0086.VSD

- 14 Replace the two screws that secure the holder to the chassis.
- 15 Replace the bottom panel (see [“Replacing the Bottom Panel”](#) on page 26).
- 16 Replace the front panel (see [“Replacing the Front Panel”](#) on page 25).
- 17 Replace the left side panel (see [“Replacing the Left Side Panel”](#) on page 27).
- 18 Reconnect the power cord and then turn on your computer.

Your computer automatically recognizes the new drive and configures itself accordingly when you turn it on. Format and partition the new drive following the instructions provided with the drive.

Chapter 4

System Board

This chapter identifies each component on the system board and provides a detailed description of each connector and jumper on the system board.

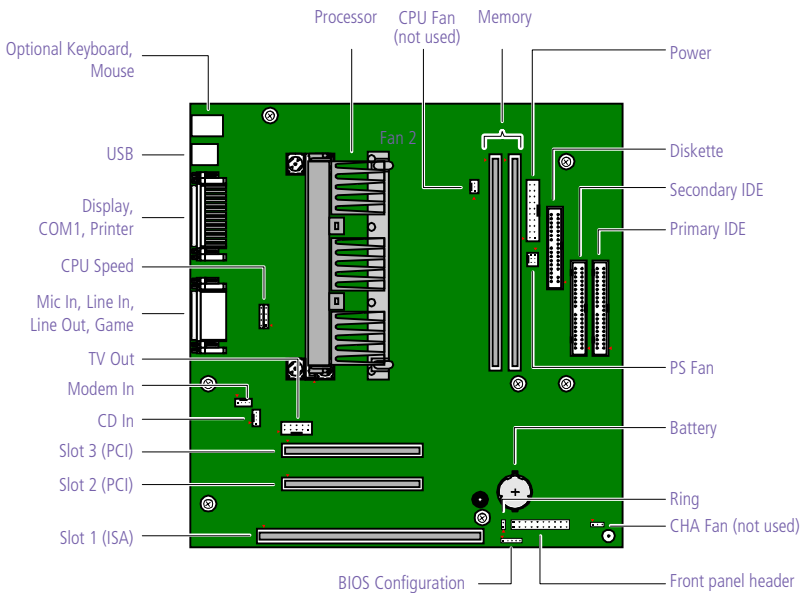

OM04581.VSI

Connectors

Front Panel Header

The front panel header is a 20-inch header (1 pin is removed for the key) that provide connections to various front panel functions. A 20-pin connector with only eight wires is used to interface the system board to the front panel.

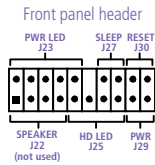
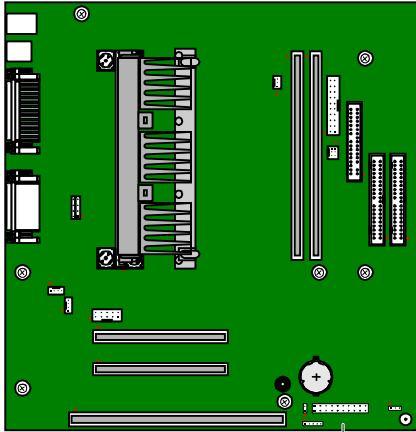

KY0031.VSD

Connector	Name	Description
J22	SPEAKER	(not used)
J23	PWR LED	Connects to the power-on indicator light on the front panel
J25	HD LED	Connects to the hard disk drive access light on the front panel
J27	SLEEP	(not used)
J29	PWR	Connects to the power-on switch on the front panel
J30	RESET	(not used)

Diskette Drive Connector

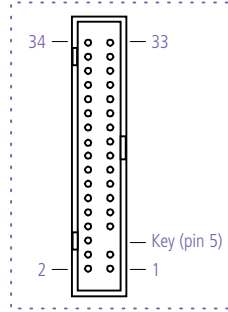
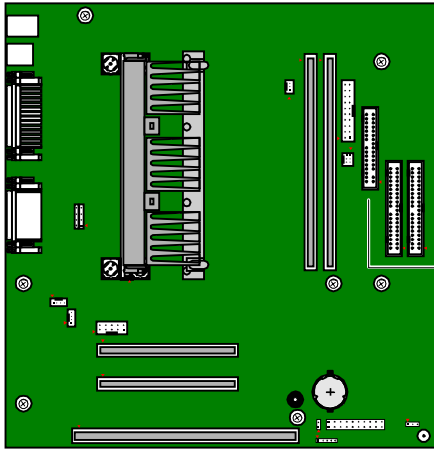

OM04701H.VSI

Memory Module (DIMM) Connectors

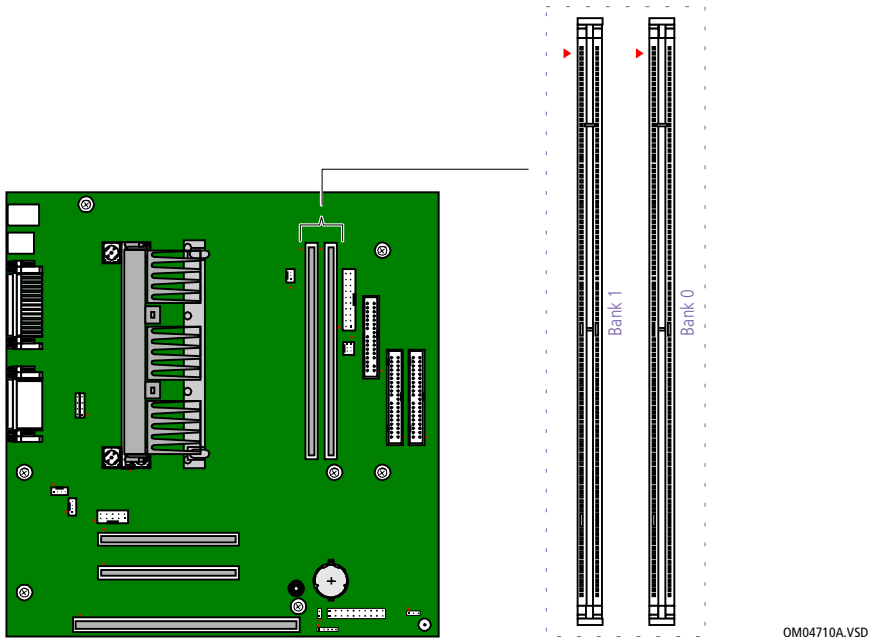

Both sides of each Dual Inline Memory Module (DIMM) look very similar. The side with pin 1 has a small "1" to the left of pin 1. Be sure to orient a DIMM correctly in the DIMM connector (a small triangle on the connector indicates pin 1).

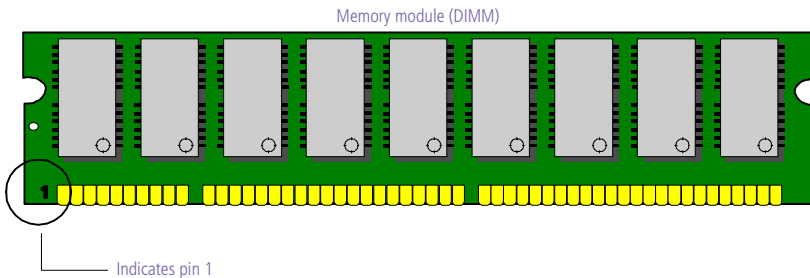

Slot Connectors

There are a total of three slot connectors: one ISA (slot #1) and two PCI slot connectors (slot #2 and #3). The ISA slot is occupied by the fax/modem card. The two PCI slot connectors are available for PCI cards.

 Slot #2 and #3 (PCI) connectors do not support bus mastering.

ISA Slot Connector

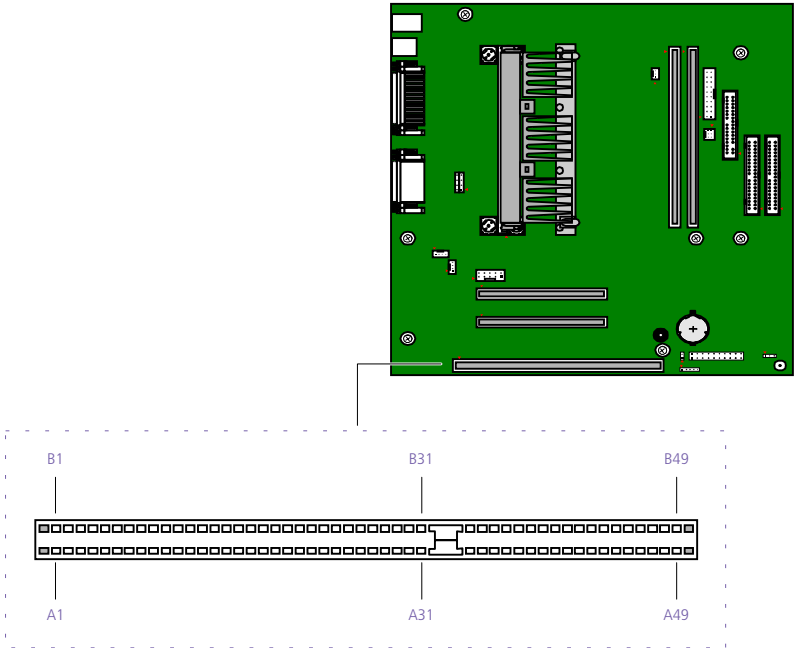

OM04712A.VSD

PCI Slot Connectors

There are two PCI slot connectors. PCI slots support 32-bit 5V and Universal (3.3/5V) PCI add-in cards.

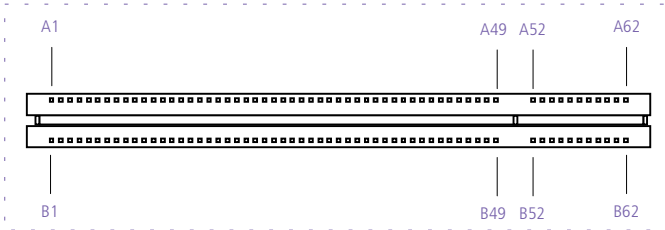
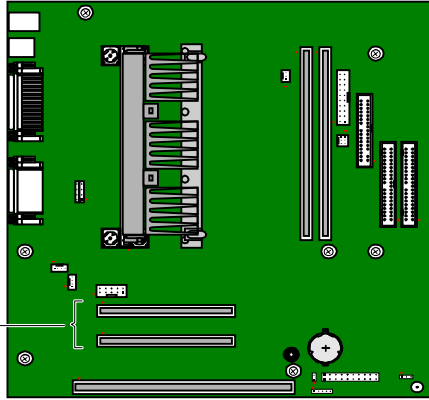

IDE Connectors

There are two IDE (Integrated Drive Electronics) connectors on the system board: a Primary IDE and a Secondary IDE connector.

Each IDE connector supports up to two IDE drives using a ribbon cable with two connectors.

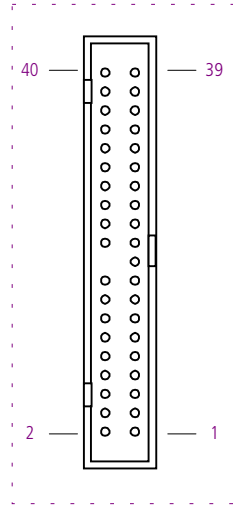
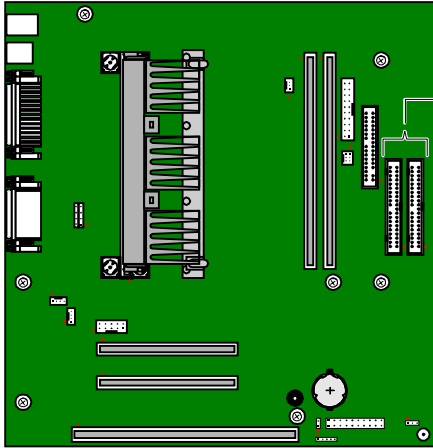

OM04701G.VSI

Power Connector

The power supply connector on the system board connects to the power supply connector labelled P1.

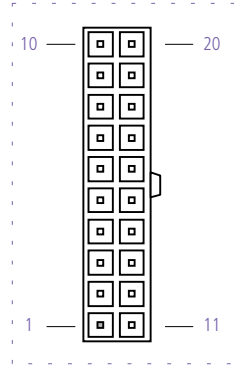
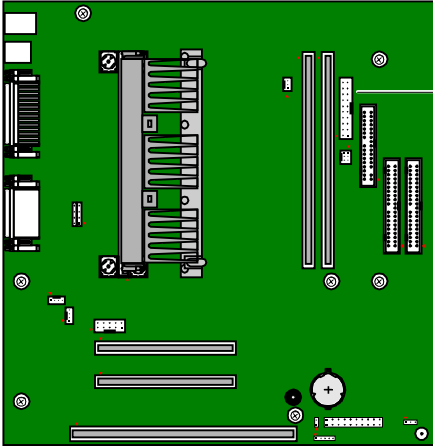

Optional Keyboard and Mouse Connectors

The optional keyboard connector and the mouse connector are 6-pin female PS/2®-type (mini-DIN) connectors. They have identical pinouts.

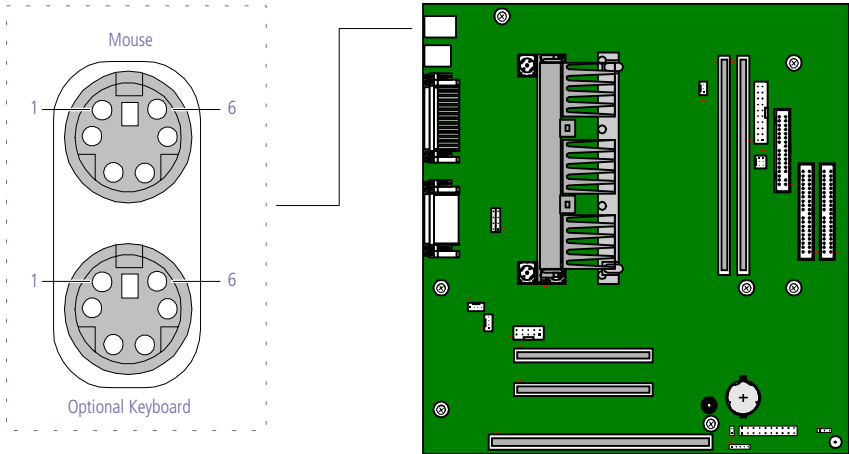

KY0032.VSD

Optional Keyboard and Mouse

Pin	Signal Name
1	DATA
2	NC
3	LOGIC GND
4	+5V (fused)
5	CLOCK
6	NC

USB Connectors

There are two standard USB ports that permit connection of two USB peripheral devices directly to the system without having to use an external hub. If more USB devices are needed, connect an external hub to either USB1 or USB2.

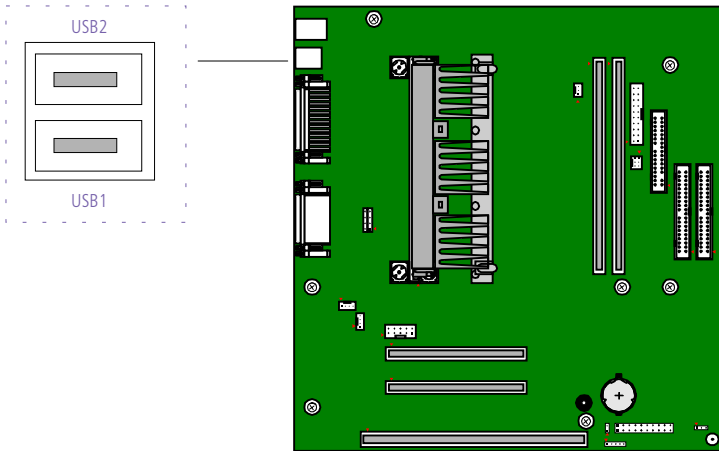

KY0033.VSD

Pin	Signal Name
1	PWR
2	SIGNAL
3	SIGNAL
4	GND

Serial, Printer, and Monitor Connectors

The Serial, Printer, and Monitor connectors are mounted in a single bracket on the system board. The Serial connector is a DB-9 male connector. The Printer connector is a DB-25 female connector. The Monitor connector is a DB-15S female connector.

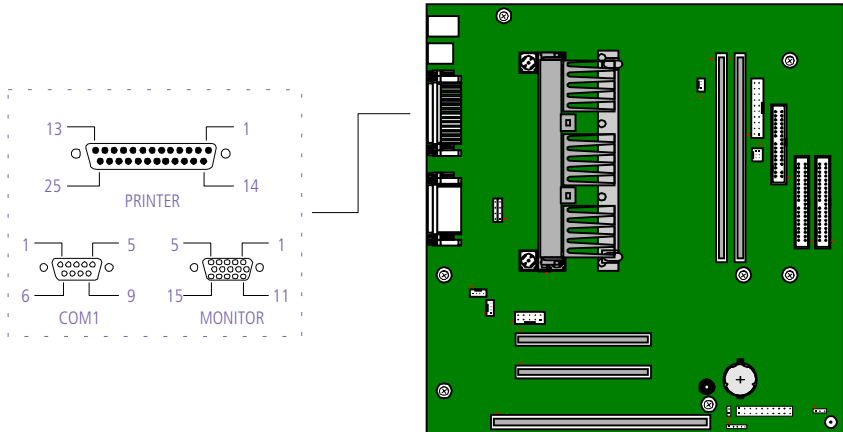

OM04701D.VSD

Serial connector

Pin	Signal Name
1	DCD
2	RXD
3	TXD
4	DTR
5	LOGIC GND
6	DSR
7	RTS
8	CTS
9	RI

Printer connector*Pin* *Signal Name*

1 STROBE -

2 DATA BIT 0

3 DATA BIT 1

4 DATA BIT 2

5 DATA BIT 3

6 DATA BIT 4

7 DATA BIT 5

8 DATA BIT 6

9 DATA BIT 7

10 ACK -

11 BUSY

12 PE

13 SELECT

14 AUTO-FEED -

15 ERROR -

16 INIT -

17 SELECT-IN -

18 LOGIC GND

19 LOGIC GND

20 LOGIC GND

21 LOGIC GND

22 LOGIC GND

23 LOGIC GND

24 LOGIC GND

25 LOGIC GND

Monitor connector

Pin *Signal Name*

1 RED

2 GREEN

3 BLUE

4 NC

5 LOGIC GND

6 RED GND RTN

7 GREEN GND RTN

8 BLUE GND RTN

9 +5V PULL-UP

10 LOGIC GND

11 NC

12 DDC DAT

13 HORIZONTAL SYNC

14 VERTICAL SYNC

15 DDC CLK

Fan Connectors

The CHA-Fan and CPU-Fan connectors are 1 x 3-pin straight header connectors and have the same pinout. PS-Fan is a 2 x 3-pin connector that controls the cooling fan in the power supply.

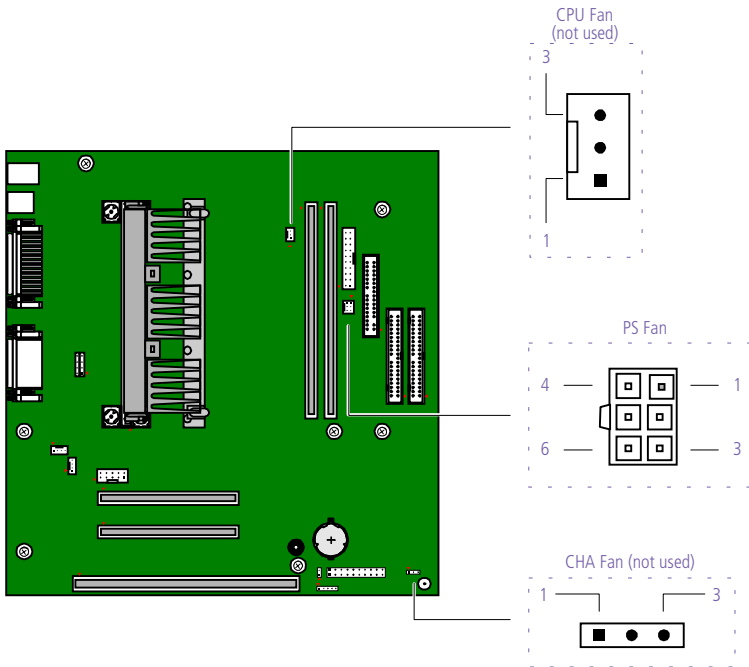

KY0034.VSD

CHA and CPU Fan Connectors

Pin	Signal Name
1	LOGIC GND
2	+12 VDC (FAN PWR ON)
3	FANTACH3

PS Fan Connector

Pin	Signal Name
1	Reserved
2	Fan On/Off
3	Reserved
4-6	Reserved

Game Connector

The Game connector is a female DB-15 connector for connecting to a game controller/joystick or MIDI device.

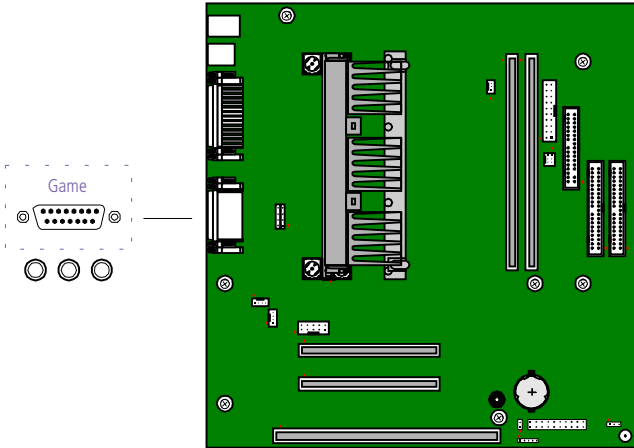

KY0056.VSC

Game Connector

Pin	Signal Name
1	+5 VDC (fused)
2	GP4 (JSBUTO)
3	GP0 (JSX1R)
4	Ground
5	Ground
6	GP1 (JSY1R)
7	GP5 (JSBUT1)
8	+5 VDC (fused)
9	+5 VDC (fused)
10	GP6 (JSBUT2)
11	GP2 (JSX2R)
12	MIDI-OUTR
13	GP3 (JSY2R)
14	GP7 (JSBUT3)
15	MIDI-INR

Headphones, Line In, Mic Connectors

The Headphones jack is a stereo mini-jack (3.5 mm) that connects to headphones. The Line In jack is a stereo mini-jack (3.5 mm) that connects to a stereo audio source (not an audio source from a video device). The Mic In jack is a stereo mini-jack (3.5 mm) that connects to a microphone.

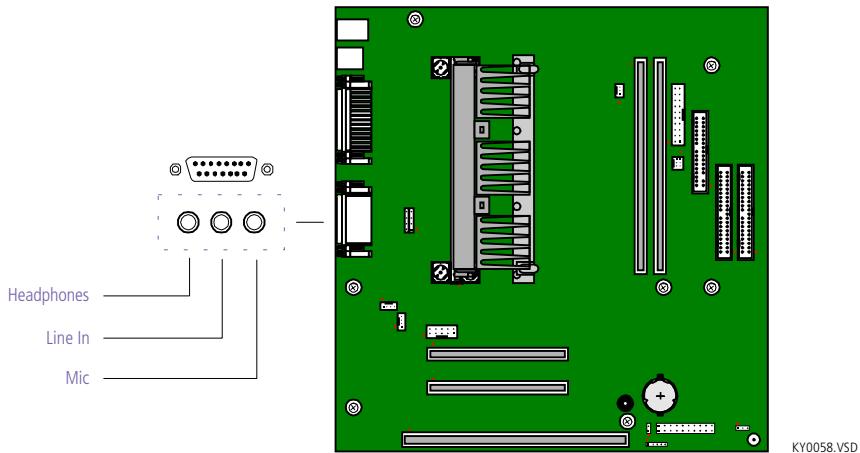

Headphones

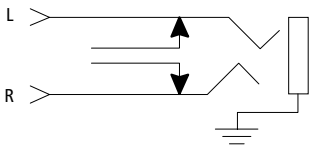

OM04713.VSD

Line In

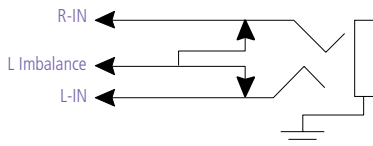

OM04713B.VSC

Mic

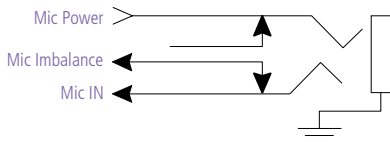

OM04713A.VSC

Ring Connector

The Ring connector (J20) is a 1 x 2-pin straight header that connects to the wake signal (J3) from the fax/modem card to enable the phone ring signal to wake the system from the sleep state.

This permits the system to go into the sleep state while monitoring the fax/modem card for a ring signal. Upon receiving an incoming phone or fax call, the ring signal on the fax/modem card wakes the system, allowing unattended reception of voice or fax messages.

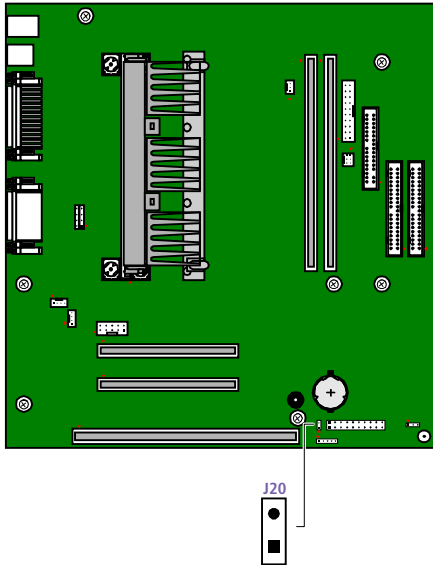

Modem In Connector

The Modem In connector (J9) on the motherboard is a 1 x 4-pin header connector and connects to the audio output connector (J4) on the fax/modem card.

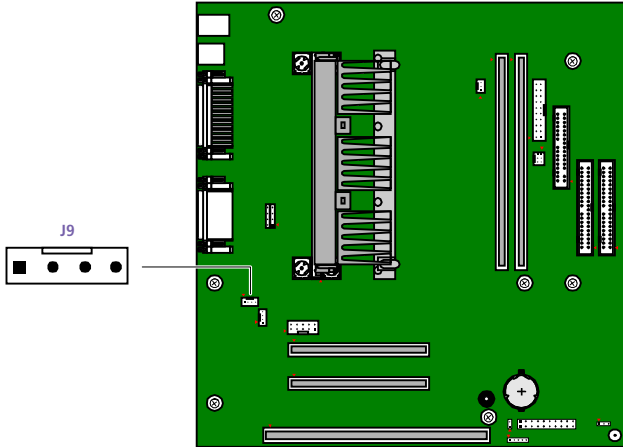

KY0061.VSD

J9

Pin	Signal Name
1	GND
2	MONO_O (to modem chip)
3	GND
4	MONO_I (to sound chip)

CD In Connector

The CD In connector (J12) on the motherboard is a 1 x 4-pin header connector and connects to the DVD-ROM drive's audio output connector.

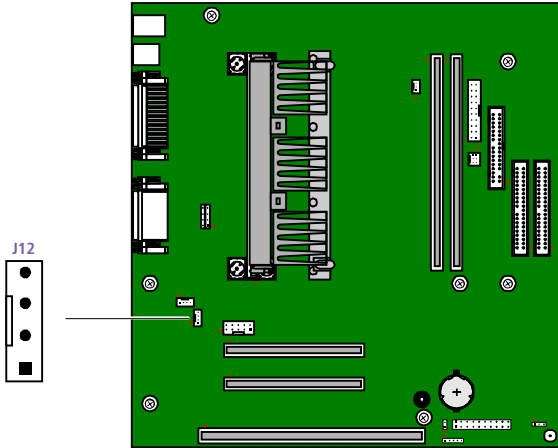

KY0062.VSD

J12

Pin	Signal Name
-----	-------------

1	LEFT
---	------

2	GND
---	-----

3	GND
---	-----

4	RIGHT
---	-------

TV Out Connector

The TV Out connector (J16) on the motherboard is a 2 x 5-pin straight header connector and connects to the composite video out connector (J5) on the TV-Out Paddle card.

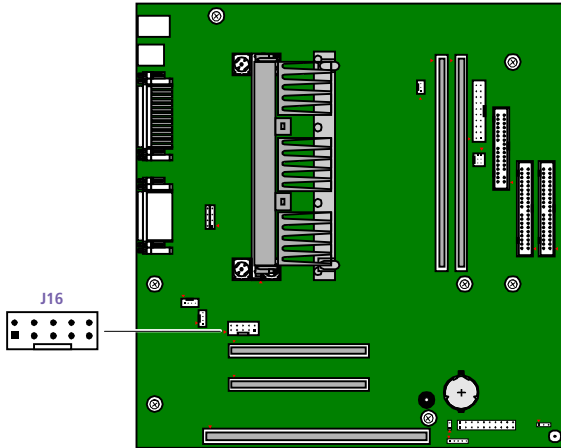

KY0063.VSD

J16

Pin	Signal Name
1	GND
2	COMPOSITE OUT
3	GND
4	LUMINANCE OUT
5	GND
6	CHROMINANCE OUT
7	GND
8	RESERVED
9	NC
10	NC

Configuration Jumpers

The configuration jumpers provide for CPU speed (JP1), password clear (JP2), and BIOS recovery (JP3) selections.

CPU Speed

The processor speed jumper (JP1) is a 2 x 5 header that is preconfigured for the maximum speed, as shown in the following table.

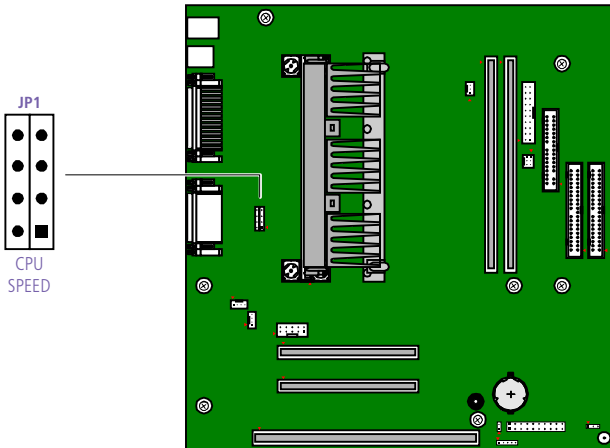

OM04588.VSD

JP1

Position	Pins 1 - 2	Pins 3 - 4	Pins 5 - 6	Pins 7 - 8
266 MHz	OFF	ON	ON	ON
300 MHz	OFF	ON	ON	OFF
333 MHz (default)	OFF	OFF	ON	ON

Clear Password and BIOS Recovery

The computer is shipped with an unused jumper cap on pins 2 and 3 (pin 3 is floating) for future use. The jumper cap should remain in this inactive position unless otherwise directed by a technical support person.

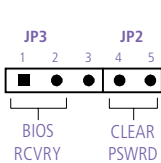
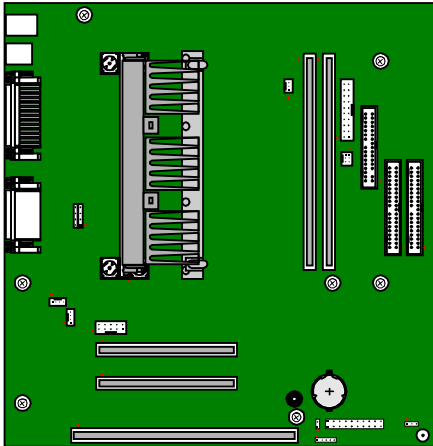

KY0059.VSC

JP2, JP3

<i>Position</i>	<i>Pins</i>	<i>Description</i>
BIOS RCVRY	1 - 2	BIOS recovery mode
CLEAR PSWRD	4 - 5	Password clear mode

Chapter 5

TV-Out Paddle Card

The TV-Out Paddle card is installed in I/O slot #4, but does not occupy a slot on the system board. Instead, a ribbon cable connects between J5 on the TV-Out Paddle card and J16 on the system board. The two connectors on the front of the I/O bracket provide composite video out and S Video out.

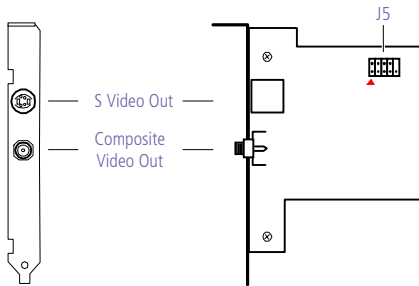

KY0035.VS

Connectors

<i>Name</i>	<i>Connector Type</i>	<i>Description</i>
S Video Out	S-video connector	Connects to S video input of video device
Composite Video Out	RCA phono jack, yellow band	Connects to video input of composite video device

Chapter 6

Fax/Modem Card

The fax/modem card occupies ISA slot #1. A two-wire twisted-pair cable connects JP3 on the fax/modem card to J20 (Ring) on the system board. Another two-wire twisted-pair cable connects J4 on the fax/modem card to J9 (Modem In) on the system board.

There are two RJ-11 jacks: one to connect a telephone line, and one to connect a phone.

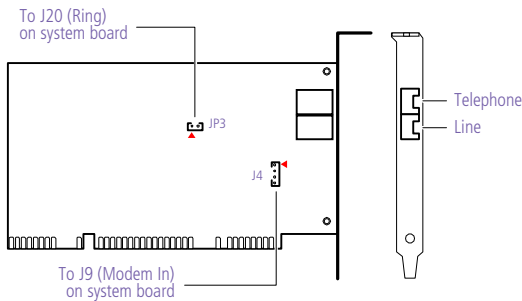

KY0038.VSI

Connectors

<i>Name</i>	<i>Connector Type</i>	<i>Description</i>
Telephone	RJ-11	Connects to phone
Line	RJ-11	Connects to telephone line
J4	4-pin connector on board	Connects to Modem In (J9) connector on system board
JP3	2-pin header	Connects to Ring (J20) connector on system board

Chapter 7

BIOS Setup Options

This chapter describes each screen in the PhoenixBIOS Setup Utility (see “Accessing the BIOS Setup Utility” on page 16).

The PhoenixBIOS setup has six menu items on the menu bar. These are:

- ❑ Main
- ❑ Advanced
- ❑ Security
- ❑ Power
- ❑ Boot
- ❑ Exit

Options that you can change are enclosed in brackets. Text that is not enclosed in brackets cannot be changed.

A small triangle (▶) indicates that there is a sub-menu with additional information and options. Press Enter to open the sub-menu. The information and options in a sub-menu are context-sensitive (they appear or disappear, depending on other selected options).

The item shown in [brackets] in this guide is the default option. The option shown in [brackets] on the screen is the current option. The available options are shown without brackets in this guide, directly below the default option. The available options are listed in the order they occur when you press the + key.

To change an option, use the left and right arrow keys to choose the menu item. Use the up and down arrow keys to select an option. Press Enter if the option is a sub-menu, or press the + or - key to cycle through the other options.

Press Esc to go back to the main menu. Press F10 to save the changes and exit, or press Esc to discard the changes. Follow the on-screen prompts for other choices. The bottom of the screen presents a summary of the keys to use for navigation and control.

Main Screen

System Time: [00:00:00]
System Date: [01/01/1988]
Language: [English (US)]

Legacy Diskette A: [Disabled]
360 KB 5¼"
1.2 MB 5¼"
720 KB 3½"
1.44/1.25 MB 3½"
2.88 MB 3½"

Legacy Diskette B: [Disabled]
360 KB 5¼"
1.2 MB 5¼"
720 KB 3½"
1.44/1.25 MB 3½"
2.88 MB 3½"

▶Primary Master	[Example: 8455MB]
Type:	[AUTO] NONE CD-ROM ATAPI Removable IDE Removable USER CHS Format
Cylinders* :	[Example: 16383]
Heads*:	[Example: 16]
Sectors*:	[Example: 63]
Total Sectors*:	[Example: 16514064] LBA Format
Maximum Capacity*:	Example: 8455 MB
Multi-Sector Transfers†:	[Example: 16 Sectors] Enabled 2 Sectors 4 Sectors 8 Sectors
LBA Mode Control†:	[Enabled] Disabled
32 Bit I/O†:	[Enabled] Disabled
Transfer Mode†:	[Fast PIO 4] FPIO 3/DMA 1 FPIO 4/DMA 2 Standard Fast PIO 1 Fast PIO 2 Fast PIO 3
Ultra DMA Mode†:	[Mode 2] Disabled Mode 0 Mode 1

* This option appears when Type is set to User or Auto and the device is a hard drive.

† This option is enabled when Type is not set to NONE or Auto.

▶Primary Slave	[None]
Type:	[AUTO] NONE CD-ROM ATAPI Removable IDE Removable USER
Maximum Capacity*:	0 MB
Multi-Sector Transfers†:	[Disabled] 2 Sectors 4 Sectors 8 Sectors 16 Sectors
LBA Mode Control†:	[Disabled] Enabled
32 Bit I/O†:	[Enabled] Disabled
Transfer Mode†:	[Standard] Fast PIO 1 Fast PIO 2 Fast PIO 3 Fast PIO 4 FPIO 3/DMA 1 FPIO 4/DMA 2
Ultra DMA Mode†:	[Disabled] Mode 0 Mode 1 Mode 2

* This option appears when Type is set to User or Auto and the device is a hard drive.

† This option is enabled when Type is not set to NONE or Auto.

▶Secondary Master	[CD-ROM]
Type:	[AUTO] NONE CD-ROM ATAPI Removable IDE Removable USER
Maximum Capacity*:	0 MB
Multi-Sector Transfers†:	[Disabled]
LBA Mode Control†:	[Disabled]
32 Bit I/O†:	[Enabled] Disabled
Transfer Mode†:	[Fast PIO 4] FPIO 3/DMA 1 FPIO 4/DMA 2 Standard Fast PIO 1 Fast PIO 2 Fast PIO 3
Ultra DMA Mode†:	[Disabled] Mode 0 Mode 1 Mode 2

* This option appears when Type is set to User or Auto and the device is a hard drive.

† This option is enabled when Type is not set to NONE or Auto.

▶Secondary Slave	[None]
Type:	[AUTO] NONE CD-ROM ATAPI Removable IDE Removable USER
Cylinders* :	[0]
Heads*:	[1]
Sectors*:	[0]
Maximum Capacity*:	0 MB
Multi-Sector Transfers†:	[Disabled]
LBA Mode Control†:	[Disabled] Enabled
32 Bit I/O†:	[Enabled] Disabled
Transfer Mode†:	[Standard] Fast PIO 1 Fast PIO 2 Fast PIO 3 Fast PIO 4 FPIO 3/DMA 1 FPIO 4/DMA 2
Ultra DMA Mode†:	[Disabled] Mode 0 Mode 1 Mode 2
QuickBoot Mode:	[Enabled] Disabled
System Memory:	640 KB
Extended Memory:	64512 KB

* This option appears when Type is set to User or Auto and the device is a hard drive.

† This option is enabled when Type is not set to NONE or Auto.

Advanced Screen

Plug and Play OS:	[No] Yes
Reset Configuration Data:	[No] Yes
USB Legacy Support:	[Enabled] Disabled
▶ PCI Configuration	
▶ PCI Device, Slot #1	
Option ROM Scan:	[Enabled] Disabled
Enable Master:	[Disabled] Enabled
Latency Timer:	[0040h] 0060h 0080h 00A0h 00C0h 00E0h Default 0020h
▶ PCI Device, Slot #2	
Option ROM Scan:	[Enabled] Disabled
Enable Master:	[Disabled] Enabled
Latency Timer:	[0040h] 0060h 0080h 00A0h 00C0h 00E0h Default 0020h
Secured Set Configuration	[No] Yes

▶I/O Device Configuration

Serial port A:	[Auto] Disabled Enabled
Base I/O address*:	[3F8] 2F8 3E8 2E8
Interrupt*:	[IRQ 4] IRQ 3
Parallel port:	[Enabled] Disabled Auto
Mode†:	[ECP] Output only Bi-directional EPP
Base I/O address‡:	[378] 278 3BC
Interrupt‡:	[IRQ 7] IRQ 5
DMA channel**:	[DMA 1] DMA 3
Floppy disk controller:	[Enabled] Auto Disabled
Base I/O address:	[Primary] Secondary
Large Disk Access Mode:	[DOS] Other
Local Bus IDE adapter:	[Both] Disabled Primary Secondary
Sound:	[Enabled] Disabled

* This option appears only if the port is set to Enabled.

† This option appears only if the port is set to Auto or Enabled.

‡ This option appears only if the port is set to Enabled and Mode is not set to EPP.

** This option appears only if the port is set to Enabled and Mode is set to ECP.

▶Advanced Chipset Control

Enable memory gap:

[Disabled]
Conventional
Extended

Security Screen

User Password Is:	Clear
Supervisor Password Is:	Clear
Set User Password	[Enter]
Set Supervisor Password	[Enter]
Password on boot:	[Disabled] Enabled

Power Screen

Power Savings:	[Disabled] Customized Maximum Power Savings Maximum Performance
Auto Suspend Timeout:	[Off] 5 Minutes 10 Minutes 15 Minutes 20 Minutes 30 Minutes 40 Minutes 60 Minutes
Resume on Modem Ring:	[On] Off
Resume on Time:	[On] Off
Resume Time:	[00:00:00]
AC LOSS Control	[Disabled] Enabled
▶Advanced Options	
IDE Drive 0 Monitoring:	[Enabled] Disabled
IDE Drive 1 Monitoring:	[Enabled] Disabled
IDE Drive 2 Monitoring:	[Disabled] Enabled
IDE Drive 3 Monitoring:	[Disabled] Enabled
Audio, Joystick	[Enabled] Disabled
Floppy Disk Drive	[Enabled] Disabled
Serial Port A	[Enabled] Disabled
Serial Port B or Modem	[Enabled] Disabled
Parallel Port	[Enabled] Disabled

Keyboard, Mouse, Video	[Enabled] Disabled
PCI Bus Mastering	[Disabled] Enabled

Boot Screen

1. [ATAPI CD-ROM Drive]
2. [Removable Devices]
3. [Hard Drive]

▶Hard Drive

1. [Example: IBM-DHEA-38451]
2. [Bootable Add-in Card]

▶Removable Devices

1. [Legacy Floppy Drives]

Floppy check: [Enabled]
Disabled

Exit Screen

Exit Saving Changes

Exit Discarding Changes

Load Setup Defaults

Discard Changes

Save Changes

Chapter 8

Miscellaneous Technical Information

This chapter contains information on the following subjects:

- ❑ User and Supervisor password
- ❑ Beep code error messages
- ❑ PCI configuration status and error messages
- ❑ DMA channel assignments
- ❑ IRQ assignments
- ❑ System I/O address map
- ❑ Memory map

About User and Supervisor Passwords

The system allows you to specify up to two passwords (a User password and a Supervisor password) in the BIOS Setup Utility. The User password is required; the Supervisor password is optional.

Access to the BIOS Setup Utility depends on which passwords were previously set, as indicated next.

<i>If you set these passwords...</i>	<i>...the following passwords are required:</i>
User password only	User password is required at bootup.
Supervisor password only	No password is required at bootup. Supervisor password is required by most setup options.
Both passwords	User password is required at bootup. Supervisor password is required by most setup options.

Beep Code Error Messages

During a normal bootup, a single short beep signifies that the system is OK. Other beep patterns signify errors. The number of beeps indicates the specific error that occurred.

The Sony Online Support technical representative will need to know how many beeps your system produces if there is an error, so be sure to count the number of beeps before calling for support.

PCI Configuration Status And Error Messages

The following is a list of status and error messages that may appear on your system from time to time.

<i>Message</i>	<i>Meaning</i>
Floppy Disk Controller Resource Conflict	The diskette controller has requested a resource that is already in use.
NVRAM Checksum Error, NVRAM Cleared	The NVRAM data was reinitialized due to an NVRAM checksum error.
NVRAM Cleared By Jumper	The Clear CMOS jumper block has been changed to the clear position.
NVRAM Data Invalid, NVRAM Cleared	Invalid entry in the NVRAM.
Parallel Port Resource Conflict	The parallel port has requested a resource that is already in use.
PCI Error Log is Full	This message is displayed when more than 15 PCI conflict errors are detected. No additional PCI errors can be logged.
PCI I/O Port Conflict	Two devices requested the same resource, resulting in a conflict.
PCI IRQ Conflict	Two devices requested the same resource, resulting in a conflict.
PCI Memory Conflict	Two devices requested the same resource, resulting in a conflict.
Primary Boot Device Not Found	The designated primary boot device (hard disk drive, diskette drive, CD-ROM drive, or network drive) could not be found.
Primary IDE Controller Resource Conflict	The primary IDE controller has requested a resource that is already in use.
Primary Input Device Not Found	The designated primary input device (keyboard, mouse, or other, if input is redirected) could not be found.
Primary Output Device Not Found	The designated primary output device (display, serial port, or other, if input is redirected) could not be found.
Secondary IDE Controller Resource Conflict	The secondary IDE controller has requested a resource that is already in use.
Serial Port 1 Resource Conflict	Serial port 1 has requested a resource that is already in use.

Serial Port 2 Resource Conflict	Serial port 2 has requested a resource that is already in use.
Static Device Resource Conflict	A non-Plug and Play ISA card has requested a resource that is already in use.
System Board Device Resource Conflict	A non-Plug and-Play ISA card has requested a resource that is already in use.

DMA Channel Assignments

This shows the factory default values. Windows 98 reassigns resources to best meet the needs of a particular configuration.

<i>DMA Channel</i>	<i>Default Assignment</i>
0	Open
1	Printer port (LPT1)
2	Standard diskette drive controller
3	ES1938 DOS emulation
4	DMA controller
5	Open
6	Open
7	Open

IRQ Assignments



This shows the factory default values. Windows 98 will reassign resources to best meet the needs of a particular configuration. PCI IRQs can be shared between several PCI devices.

<i>IRQ #</i>	<i>Default Assignment</i>
0	System timer
1	Standard 101/102-key or Microsoft® Natural Keyboard
2	Programmable interrupt controller
3	LT WinModem NV #3
4	Communications port (COM1)
5	Shared between IRQ holder for PCI steering, ES1938 PCI AudioDrive, and ES1938 AudioDrive device manager
6	Standard diskette drive controller
7	Printer port (LPT1)
8	System CMOS/real time clock
9	Shared between IRQ holder for PCI steering and Intel 82371AB/EB PCI-to-USB Universal Host Controller
10	Open
11	Shared between IRQ holder for PCI steering and Rage Pro Turbo 1X (English) (DirectX)
12	PS/2-compatible mouse port
13	Numeric data processor
14	Shared between primary IDE controller (dual FIFO) and Intel 82371AB/EB PCI bus master IDE controller
15	Shared between secondary IDE controller (dual FIFO) and Intel 82371AB/EB PCI bus master IDE controller

System I/O Address Map

<i>Address Range (hexadecimal)</i>	<i>Description</i>
0000 - 000F	DMA controller
0010 - 001F	In use by unknown device
0020 - 0021	Programmable interrupt controller
0022 - 003F	In use by unknown device
0040 - 0043	System timer
0044 - 005F	In use by unknown device
0060	Standard 101/102-key or Microsoft Natural Keyboard
0061	System speaker
0062 - 0063	In use by unknown device
0064	Standard 101/102-key or Microsoft Natural Keyboard
0065 - 006F	In use by unknown device
0070 - 0071	System CMOS/real-time clock
0072 - 007F	In use by unknown device
0080	System board resources
0081 - 008F	DMA controller
0090 - 009F	In use by unknown device
00A0 - 00A1	Programmable interrupt controller
00A2 - 00BF	In use by unknown device
00C0 - 00DF	DMA controller
00E0 - 00E1	System board resources
00E2 - 00EF	In use by unknown device
00F0 - 00FF	Numeric data processor
0108 - 010F	LT WinModem [®] NV #3
0120 - 013F	Standard universal PCI-to-USB host controller
0170 - 0177	Shared between Intel 82371AB/EB PCI bus master IDE controller and secondary IDE controller (dual FIFO)
01F0 - 01F7	Shared between Intel 82371AB/EB PCI bus master IDE controller and primary IDE controller (dual FIFO)
0200 - 0203	Gameport [™] joystick controller
0220-022F	ES1938 DOS emulation
0274 - 0277	I/O Read Data port for ISA PnP enumerator
02F8 - 02FF	LT WinModem NV #3

<i>Address Range (hexadecimal)</i>	<i>Description</i>
0330 - 0331	ES1938 DOS emulation
0376	Shared between secondary IDE controller (dual FIFO) and Intel 82371AB/EB PCI bus master IDE controller
0378 - 037B	Printer port (LPT1)
0388 - 038B	ES1938 DOS emulation
03B0 - 03BB	Rage Pro Turbo 1X (English) (DirectX)
03C0 - 03DF	Rage Pro Turbo 1X (English) (DirectX)
03F0 - 03F5	Standard dikette drive controller
03F6	Shared between primary IDE controller (dual FIFO) and Intel 82371AB/EB PCI bus master IDE controller
03F7	Standard diskette drive controller
03F8 - 03FF	Communications port (COM1)
04D0 - 04D1	System board resources
0778 - 077F	Printer port (LPT1)
0CF8 - 0CFF	PCI bus
1000 - 1007	Primary IDE controller (dual FIFO)
1008 - 100F	Shared between secondary IDE controller (dual FIFO) and Intel 82371AB/EB PCI bus master IDE controller
1010 - 1013	ES1938 PCI AudioDrive device manager
1014 - 1017	Intel 82371AB/EB PCI-to-USB Universal Host Controller
1040 - 104F	System board resources

Memory Map

<i>Address range</i>	<i>Default configuration</i>
00000000 - 0009FFFF	System board extension for PnP BIOS
000A0000 - 000AFFFF	Rage Pro Turbo 1X (English) (DirectX)
000B0000 - 000BFFFF	Rage Pro Turbo 1X (English) (DirectX)
000C0000 - 000CBFFF	Rage Pro Turbo 1X (English) (DirectX)
000E0000 - 000FFFFF	System board extension for PnP BIOS
00100000 - 03FFFFFF	System board extension for PnP BIOS
F4000000 - F4000FFF	Rage Pro Turbo 1X (English) (DirectX)
F4000000 - F40FFFFF	Intel 82443LX/EX Pentium [®] II processor-to-AGP controller
F4020000 - F403FFFF	Rage Pro Turbo 1X (English) (DirectX)
F5000000 - F5FFFFFF	Shared between Intel 82443LX/EX Pentium [®] II processor-to-AGP controller and Rage Pro Turbo 1X (English) (DirectX)
F8000000 - FBFFFFFF	Intel 82443LX/EX Pentium [®] II processor-to-PCI bridge controller
FFF80000 - FFFFFFFF	System board resources

Chapter 9

Specifications

This chapter describes the technical specifications for the Sony PCV-E204.

Processor

333 MHz Intel Pentium® II processor

Memory Modules (DIMMs)

Installed memory	64 Mbytes SDRAM (66 MHz)
Maximum memory	256 Mbytes in two 168-pin DIMM sockets
Voltage	3.3 V memory only
Pins	168-pins with gold-plated contacts
SDRAM type	60 ns, unrestricted CAS latency 2, unbuffered, Intel 4-clock, 64 bits (non-ECC) or 72 bits (ECC)

DIMM Configurations

<i>DIMM Size*</i>	<i>Non-ECC (64 bits) and ECC (72 bits)</i>
8 MB	1 Mbit
16 MB	2 Mbit
32 MB	4 Mbit
64 MB	8 Mbit
128 MB	16 Mbit

* Can be installed in one or two sockets. Memory size can vary between sockets. DIMMs can be single-sided or double-sided. DIMMs must be 3.3V unbuffered 4clock, 64-bit or 72-bit 66MHz SDRAM module, Rev 1.0.

L2 Cache

Installed	512 kbytes secondary write-back cache (in processor)
Controller	Intel 82440EX PAC

Graphics

Controller*	Rage Pro Turbo 1X (English) (DirectX) 64-bit AGP
Video memory	4 Mbytes (installed)
Resolution (displayed resolution depends on the graphics display you are using)	
True color (32 bits)	Up to 1152 x 864 at 85 Hz non-interlaced
True color (24 bits)	Up to 1280 x 1024 at 85 Hz non-interlaced
High color (16 bits)	Up to 1280 x 1024 at 85 Hz non-interlaced
256 colors (8 bits)	Up to 1280 x 1024 at 85 Hz non-interlaced

* Supports DDC-1 and DDC-2b standards for Plug and Play displays.

Video

Video playback	"Sony-tuned" MPEG Digital Video supports full-screen playback at 30 fps, 640x480x16
Output connectors	Composite out, S Video out
Plug and Play	Configuration of DDC-compatible displays

Audio

Controller	PCI ESS Solo-1 audio accelerator
Surround sound	3D-enhanced
Audio sampling rate	Up to 48 kHz at 16 bits
Rear panel connectors	Mic (for microphone) Line In (from stereo audio source) Headphones (for stereo headphone)

Communications

Modem	V.90-compatible data/fax modem
Fax/modem	14.4 kbps

I/O and Expansion Slots

Serial ports	One high-speed NS16C550-compatible port
Parallel port	One high-speed bi-directional Centronics-compatible port with ECP and EPP modes
MIDI/game port	One (supports MIDI in/out or two joysticks — adapter cable not supplied)
Modem ports	Two RJ-11 connectors (for line and phone)
USB ports	USB 1 and USB 2
PCI slots	Two available slots. Maximum length for add-in cards is 7.75 inches
ISA slots	One (occupied by fax/modem card). Maximum length for add-in card is 10.5 inches.
IDE connectors	Primary and Secondary (each supports two IDE drives)

Drives and Controllers

Diskette controller	765A-compatible (supports up to 2.88 MByte)
Diskette drive	1.44 MByte 3.5-inch MFDD
EIDE controller	Supports up to four EIDE drives (supports PIO Mode 4 EIDE drives and Ultra DMA/33 Mode drives)
IDE hard drive	5.1 GByte (bus-mastering EIDE driver installed)
DVD-ROM drive	DVD-ROM disc: 4X (maximum performance). [*] CD-ROM disc: 24X (maximum performance).

^{*} DVD-ROM drive also plays CD-ROM discs. Data on the DVD-ROM is read at a variable transfer rate, ranging from 2X at the innermost track to 4X at the outermost track (the data transfer standard 1X rate is 1385 kbytes/s). The average data transfer rate is 3.3X (4616 kbytes/s). Data on a CD-ROM disc is read at a variable transfer rate, ranging from 10X at the innermost track to 24X at the outermost track (the data transfer standard 1X rate is 150 kbytes/s). The average data transfer rate is 17X (2250 kbytes/s).

BIOS

Make and model	Phoenix BIOS
ROM	256 kbytes flash [*]
Passwords	User and supervisor passwords supported
Recovery boot block	Supported
Power management	Supports ACPI
Plug and Play devices	Supported

^{*} Flash-ROM update utility is available from Sony's website at <http://www.sony.com/pcsupport>.

Power Supply

Power management control	Software
Processor voltage regulator	On system board
Power	135 W peak, 90 W continuous
Current draw (maximum)	1.5A at 12 VDC 12A at 5 VDC* 6A at 3.3 VDC* 0.2A at -12 VDC 0.72A at +5VSB

* 5V current to expansion slots should not exceed 2A per slot. Combined 5V and 3.3V power not to exceed 30W.

CPU Environment

Operating temperature	10 to 35°C (50 to 95°F)
Non-operating (storage) temperature	-30 to 60°C (-22 to 140°F)
Operating humidity	80% RH at 36°C (with no hard disk drive)
Non-operating humidity	92% RH at 36°C
Dimensions	Approx. 7 in (w) x 12 in (h) x 13 ¾ in (d) (178 x 305 x 349 mm)
Weight (without monitor) as shipped	Approx. 17 lb (7.71 kg)

Index

A

- add-in card
 - installing **28**
 - removing **29**
- address map, system **96**
- audio specifications **100**

B

- battery - See lithium battery
- beep codes **91**
- BIOS setup utility **16**
 - advanced screen **80**
 - boot screen **86**
 - exit screen **87**
 - main screen **75**
 - options **73**
 - power screen **84**
 - screens **73**
 - security screen **83**
- BIOS specifications **101**
- bottom panel
 - removing **23**
 - replacing **26**

C

- card
 - modem **71**
 - TV-Out paddle **69**
- CD-ROM disc - See DVD-ROM drive
- CMOS - See Also BIOS
- codes, beeps **91**
- COM1 port - See Serial communications, specifications **100**
- composite video out connector **70**
- computer safety information **ii**

- configuration jumper
 - BIOS recovery **67**
 - CPU Speed **67**
 - password clear **67**
- configuring
 - BIOS setup utility **16**
 - power management **17**
 - system board **18**
- connector
 - 4-pin on modem card **72**
 - composite video out **70**
 - fan **60**
 - keyboard **55**
 - line **72**
 - modem card **72**
 - monitor **11**
 - mouse **55**
 - power **54**
 - printer **57**
 - Serial **57**
 - telephone **72**
 - TV-Out **70**
- connectors
 - IDE **53**
 - system board **48**
 - USB **56**
- cover, slot **40**
- covering I/O slot **41**
- CPU - See processor

D

- DIMM - See memory module
- diskette drive
 - connector **49**
 - removing **39**

display - See monitor
display, power management **17**
DMA channel assignments **94**
drive
 DVD-ROM specifications **101**
 IDE connectors **53**
 specifications **101**
DVD-ROM drive
 location of **3**
 performance of discs **101**
 specifications **101**

E

environment specifications **102**
error messages
 beep codes **91**
 PCI configuration **92**
expansion slot
 specifications **101**
expansion slots **13**
expansion slots - See Also slots

F

fan connectors **60**
 CHA **60**
 CPU **60**
 PS-Fan **60**
fax card - See modem card
fax/modem - See Also
 communications
FCC Part 68 **iv**
floppy drive - See diskette drive
front panel
 removing **24**
 replacing **25**
front panel header **48**
front view **2**
 buttons and switches **4**
 connectors **5**
 drives **3**
 indicators **5**

G

graphics
 specifications **100**
graphics controller - See graphics

H

header - See front panel header

I

I/O address map **96**
I/O connectors
 game port **11**
 mic, line in, headphones **12**
 monitor **11**
 optional keyboard and mouse **9**
 printer port **10**
 S video **10**
 serial port **1 9**
 telephone and line **12**
 USB ports **9**
I/O slot covering **41**
I/O slot specifications **101**
icons, description of **7**
IDE
 connectors **53**
 specifications **101**
input devices **iii**
installing
 add-in card **28**
 system memory **34**
interference **iii**
IRQ assignments **95**
ISA slot connector **51**

J

jumper - See system board

K

keyboard connector **55**

L

L2 cache specifications **99**
lithium battery, replacing **31**

M

map - See Also I/O address map
memory
 map **98**
 specifications **99**
memory - See Also system memory

memory map **98**
 memory module
 connector **50**
 removing **37**
 specifications **99**
 messages
 error **91**
 status and error **92**
 microprocessor - See processor
 model numbers **ii**
 modem - See Also communications
 modem card
 connectors **72**
 view of **71**
 monitor - See display
 monitor connector **11**
 mouse connector **55**

N

notice to users **ii**

O

operating temperature - See environment
 output devices **iii**

P

panel
 bottom **23, 26**
 front **24, 25**
 side **22, 27**
 passwords, about **90**
 PCI slot connectors **52**
 plug & play specifications **100**
 power connector **54**
 power management, configuring **17**
 power supply specifications **102**
 printer connector **57**
 processor specifications **99**

R

radio interference **iii**
 RAM - See Also system memory
 rear view **6**
 I/O connectors **9**
 icons **7**

recording **ii**
 regulatory information **iii**
 removing
 add-in card **29**
 bottom panel **23**
 diskette drive **39**
 front panel **24**
 memory module **37**
 side panel **22**
 slot cover **40**
 replacing **27**
 bottom panel **26**
 front panel **25**
 side panel **27**
 replacing lithium battery **31**
 resolution - See graphics

S

S video out connector **70**
 safety information **ii**
 Serial connector **57**
 serial numbers **ii**
 serial port - See Serial setup, BIOS **16**
 side panel **27**
 removing **22**
 slot - See Also I/O slot
 slot connectors **51**
 ISA **51**
 PCI **52**
 slot cover, removing **40**
 specifications
 audio **100**
 BIOS **101**
 communications **100**
 drives and controllers **101**
 environment **102**
 graphics **100**
 I/O and expansion slots **101**
 L2 cache **99**
 memory **99**
 memory module **99**
 plug & play **100**
 power supply **102**
 processor **99**
 video **100**

status and error messages **92**

supervisor password **90**

system board

configuration jumpers **67**

configuring **18**

connectors **48**

diskette drive connector **49**

fan connectors **60**

front panel header **48**

IDE connectors **53**

ISA slot connector **51**

keyboard connector **55**

memory module connector **50**

mouse connector **55**

PCI slot connectors **52**

power connector **54**

Serial connector **57**

slot connectors **51**

USB connectors **56**

system I/O address map **96**

system memory, installing **34**

T

Telephone Consumer Protection Act of 1991 **iv**

TV interference **iii**

TV-Out card, connectors **70**

TV-Out paddle card

connector **70**

view of **69**

U

USB connectors **56**

user password **90**

V

video specifications **100**

W

weight - See environment